

DAIKIN

INSTALLATION MANUAL

VRV[®]-WIII System air conditioner

MODEL

RWEYQ72PTJU
RWEYQ84PTJU
RWEYQ144PTJU
RWEYQ168PTJU
RWEYQ216PTJU
RWEYQ252PTJU

English

Français

Español

Read these instructions carefully before installation.
Keep this manual in a handy place for future reference.
This manual should be left with the equipment owner.

Lire soigneusement ces instructions avant l'installation.
Conserver ce manuel à portée de main pour référence ultérieure.
Ce manuel doit être donné au propriétaire de l'équipement.

Lea cuidadosamente estas instrucciones antes de instalar.
Guarde este manual en un lugar a mano para leer en caso de tener alguna duda.
Este manual debe permanecer con el propietario del equipo.

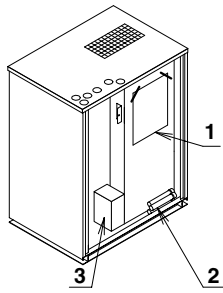
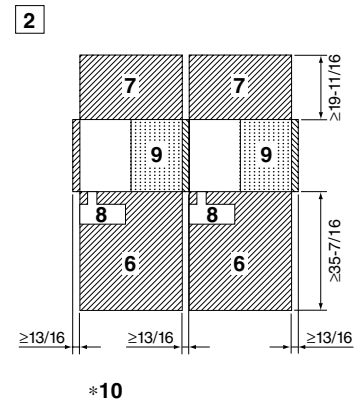
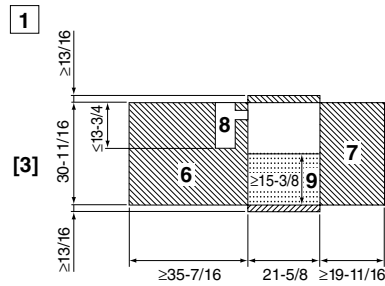

figure 1



*10

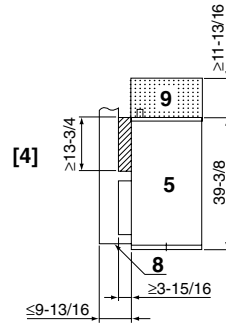

figure 2

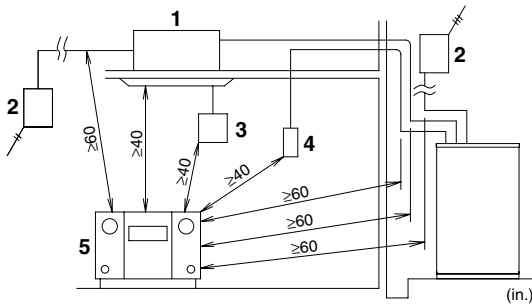

figure 3

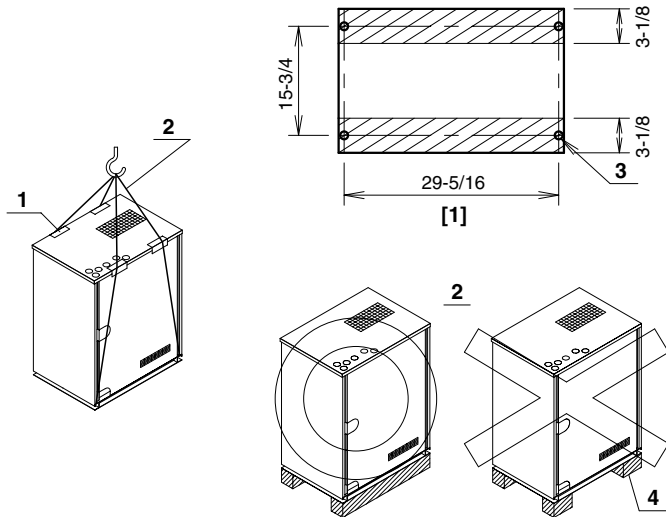

figure 4

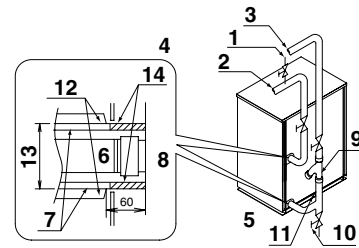

figure 6

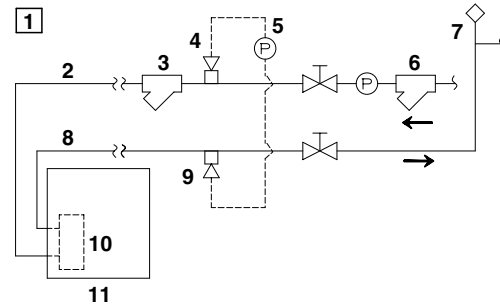

figure 7

[Heat pump system]

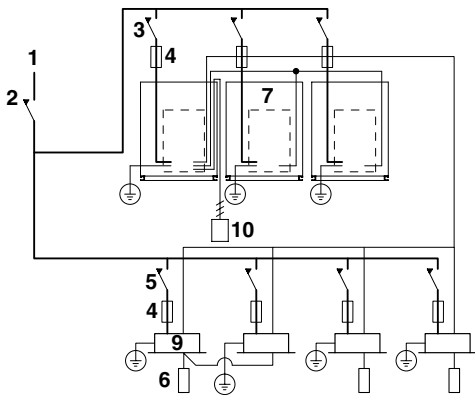

figure 8

[Heat recovery system]

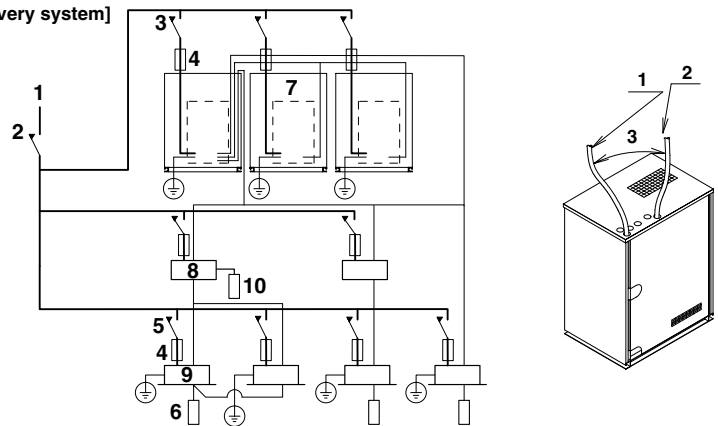
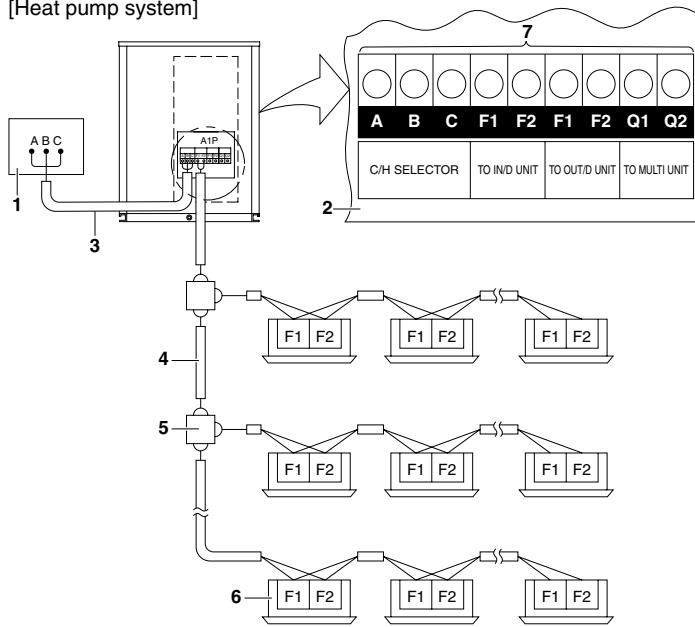

figure 9

[Heat pump system]



[Heat recovery system]

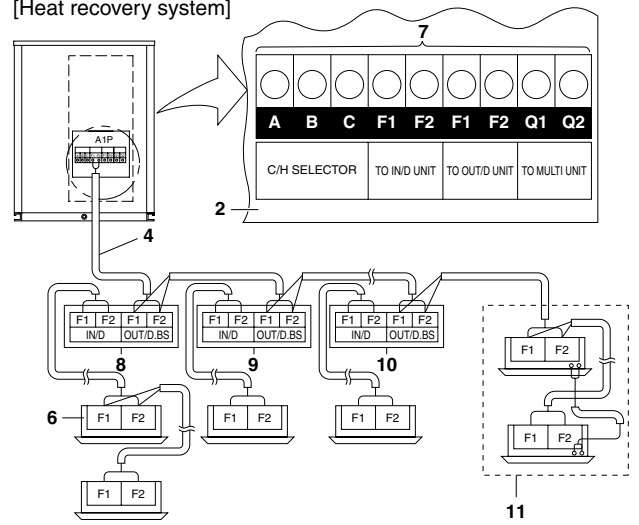

figure 10

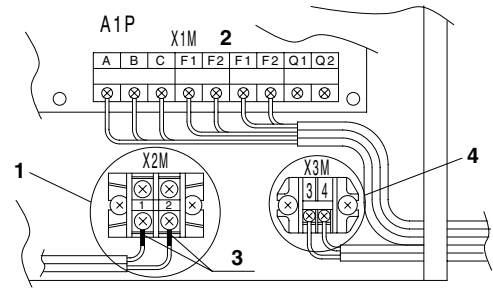
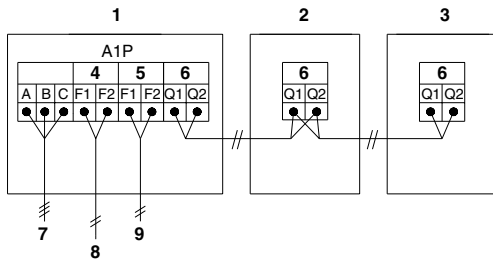

figure 11

figure 12

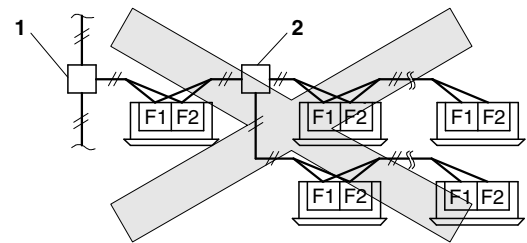
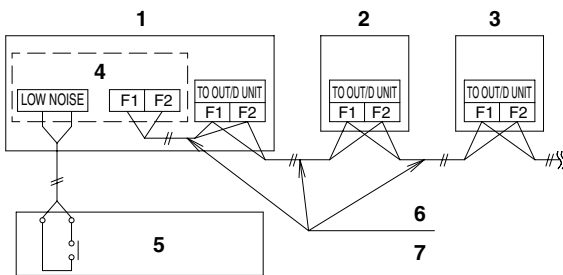

figure 13

figure 14

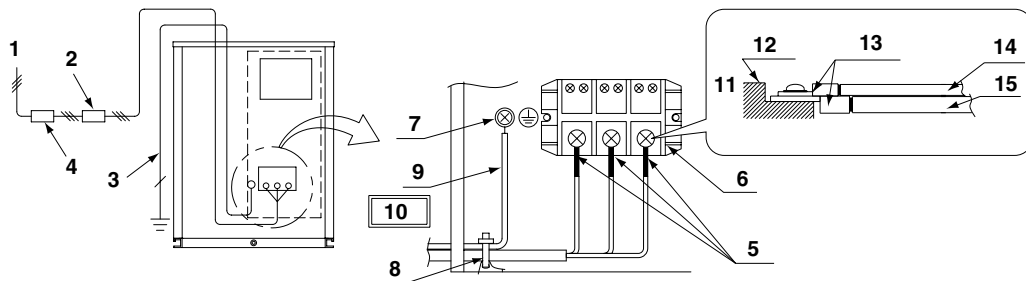

figure 15

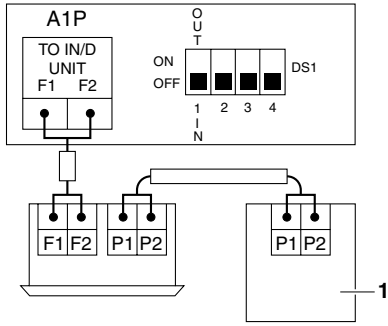

figure 16

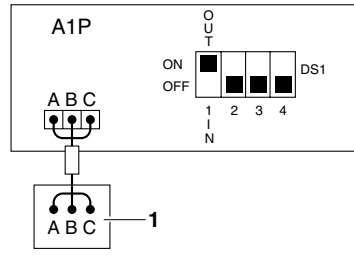

figure 17

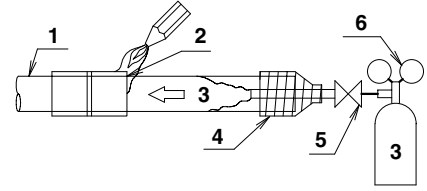

figure 18

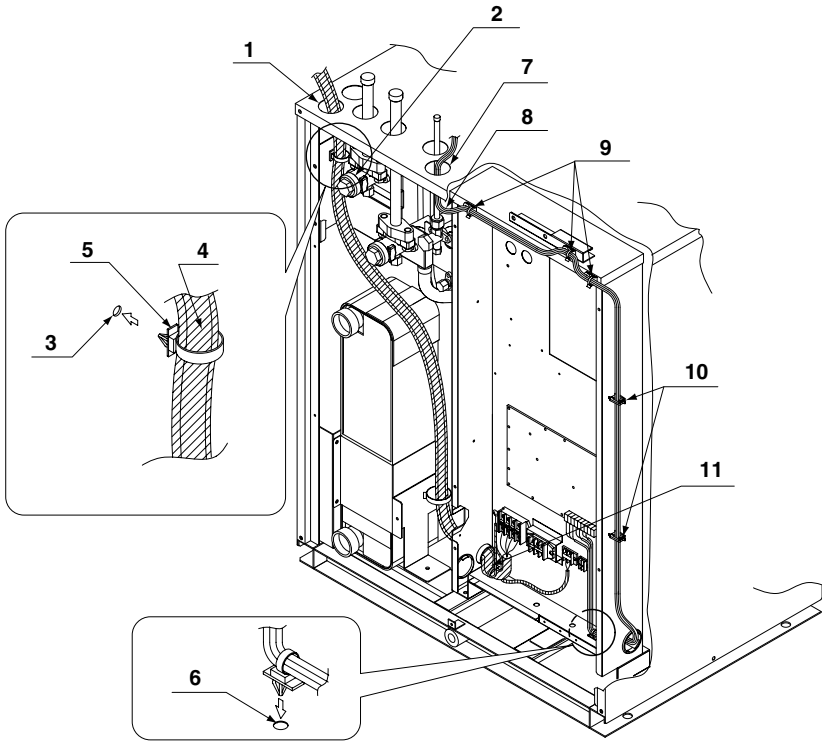
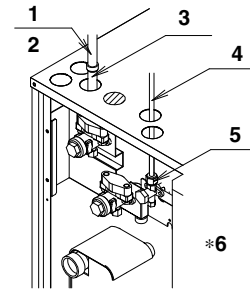

figure 19

[Heat pump system]



[Heat recovery system]

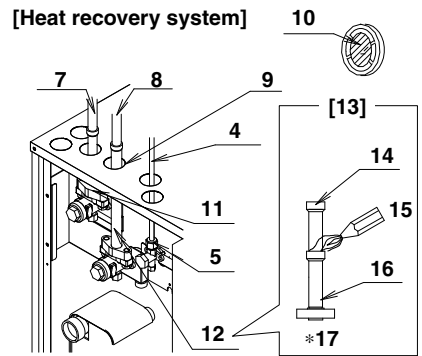
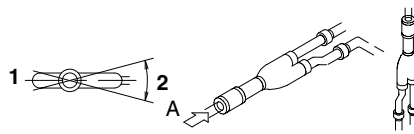
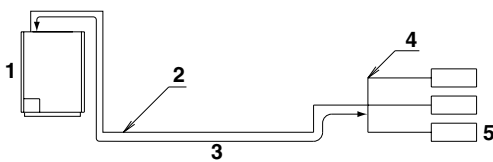
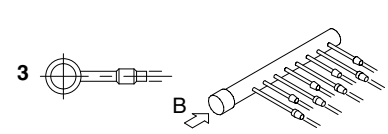

figure 20



[A-arrow view]



[B-arrow view]

figure 21

figure 22

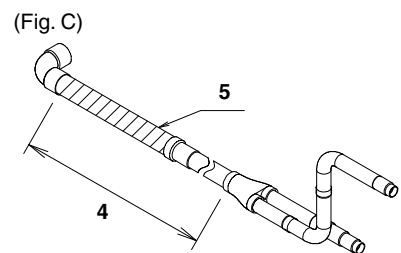
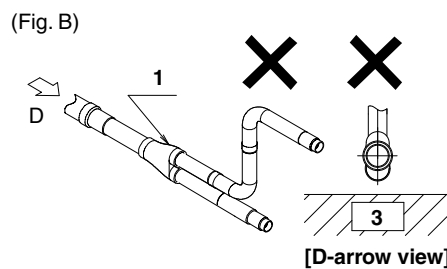
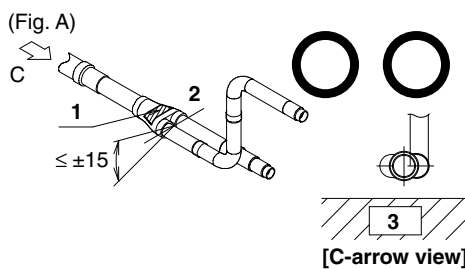
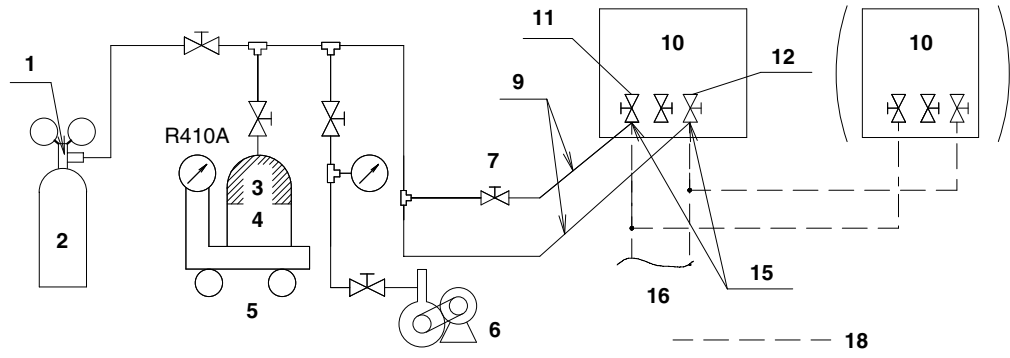

figure 23

[Heat pump system]



[Heat recovery system]

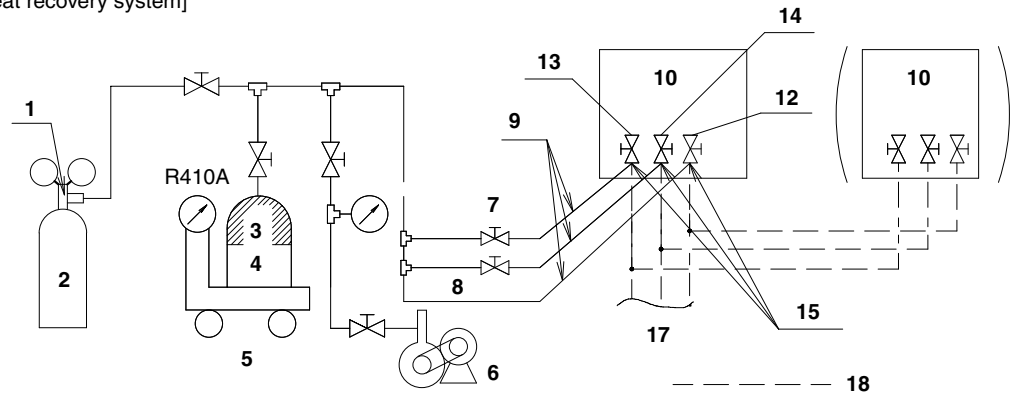

figure 24

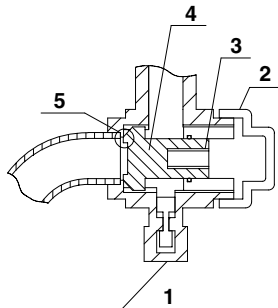

figure 25

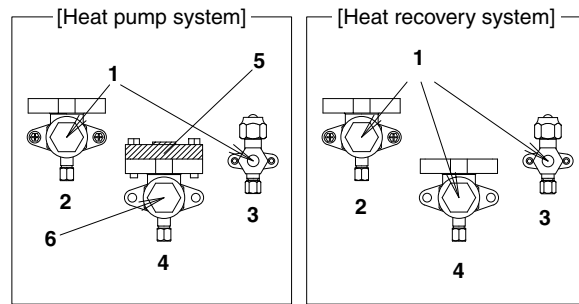

figure 26

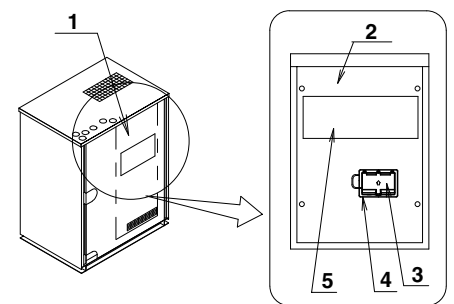

figure 27

CONTENTS

1. SAFETY CONSIDERATIONS.....	1
2. INTRODUCTION.....	3
2-1. Combination.....	3
2-2. Standard operation limit.....	3
2-3. Standard supplied accessories.....	3
2-4. Option accessory.....	3
2-5. Technical specifications (1).....	4
2-6. Electrical specifications.....	4
3. SELECTION OF LOCATION.....	5
4. INSPECTING AND HANDLING THE UNIT.....	5
5. UNPACKING AND PLACING THE UNIT.....	5
6. WATER PIPING WORK.....	6
7. HANDLING OF THE BRAZED PLATE TYPE HEAT EXCHANGER.....	6
7-1. When designing the equipment.....	6
7-2. Before starting a test run.....	6
7-3. Daily service and maintenance.....	7
7-4. Water quality.....	7
7-5. Maintenance of plate type heat exchanger.....	7
8. FIELD WIRING.....	8
8-1. Optional parts.....	8
8-2. Power circuit and cable requirements.....	8
8-3. General.....	8
8-4. Examples.....	8
8-5. In case of a local setting.....	10
9. REFRIGERANT PIPING.....	11
9-1. Selection of piping material.....	11
9-2. Protection against contamination when installing pipes.....	11
9-3. Pipe connection.....	11
9-4. Connecting the refrigerant piping.....	12
9-5. Example of connection.....	13
9-6. Air tight test and vacuum drying.....	14
9-7. Pipe insulation.....	14
9-8. Checking of device and installation conditions.....	14
9-9. Additional refrigerant charge.....	14
9-10. Stop valve operation procedure.....	15
10. CHECKS AFTER INSTALLATION.....	16
11. TEST RUN.....	16
11-1. Air discharge.....	16
11-2. Before turn on the power supply.....	16
11-3. Check operation.....	16
11-4. Check of normal operation.....	17
12. CAUTION FOR REFRIGERANT LEAKS.....	17

1. SAFETY CONSIDERATIONS

Read these **SAFETY CONSIDERATIONS for Installation** carefully before installing air conditioning equipment. After completing the installation, make sure that the unit operates properly during the startup operation.

Instruct the customer on how to operate and maintain the unit. Inform customers that they should store this Installation Manual with the Operation Manual for future reference.

Always use a licensed installer or contractor to install this product. Improper installation can result in water or refrigerant leakage, electrical shock, fire, or explosion.

Meanings of **DANGER**, **WARNING**, **CAUTION**, and **NOTE** Symbols:

 **DANGER** Indicates an imminently hazardous situation which, if not avoided, will result in death or serious injury.

 **WARNING**..... Indicates a potentially hazardous situation which, if not avoided, could result in death or serious injury.

 **CAUTION** Indicates a potentially hazardous situation which, if not avoided, may result in minor or moderate injury. It may also be used to alert against unsafe practices.

 **NOTE**..... Indicates situations that may result in equipment or property-damage accidents only.

DANGER

- **Refrigerant gas is heavier than air and replaces oxygen. A massive leak can lead to oxygen depletion, especially in basements, and an asphyxiation hazard could occur leading to serious injury or death.**
- **Do not ground units to water pipes, gas pipes, telephone wires, or lightning rods as incomplete grounding can cause a severe shock hazard resulting in severe injury or death. Additionally, grounding to gas pipes could cause a gas leak and potential explosion causing severe injury or death.**
- **If refrigerant gas leaks during installation, ventilate the area immediately. Refrigerant gas may produce toxic gas if it comes in contact with fire. Exposure to this gas could cause severe injury or death.**
- **After completing the installation work, check that the refrigerant gas does not leak throughout the system.**
- **Do not install unit in an area where flammable materials are present due to risk of explosions that can cause serious injury or death.**
- **Safely dispose all packing and transportation materials in accordance with federal/state/local laws or ordinances. Packing materials such as nails and other metal or wood parts, including plastic packing materials used for transportation may cause injuries or death by suffocation.**

WARNING

- **Only qualified personnel must carry out the installation work. Installation must be done in accordance with this installation manual. Improper installation may result in water leakage, electric shock, or fire.**
- **When installing the unit in a small room, take measures to keep the refrigerant concentration from exceeding allowable safety limits. Excessive refrigerant leaks, in the event of an accident in a closed ambient space, can lead to oxygen deficiency.**
- **Use only specified accessories and parts for installation work. Failure to use specified parts may result in water leakage, electric shocks, fire, or the unit falling.**
- **Install the air conditioner on a foundation strong enough that it can withstand the weight of the unit. A foundation of insufficient strength may result in the unit falling and causing injuries.**
- **Take into account strong winds, typhoons, or earthquakes when installing. Improper installation may result in the unit falling and causing accidents.**
- **Make sure that a separate power supply circuit is provided for this unit and that all electrical work is carried out by qualified personnel according to local state, and national regulations. An insufficient power supply capacity or improper electrical construction may lead to electric shocks or fire.**
- **Make sure that all wiring is secured, that specified wires are used, and that no external forces act on the terminal connections or wires. Improper connections or installation may result in fire.**

- When wiring, position the wires so that the terminal box lid can be securely fastened. Improper positioning of the terminal box lid may result in electric shocks, fire, or the terminals overheating.
- Before touching electrical parts, turn off the unit.
- Be sure to install a ground fault circuit interrupter if one is not already available. This helps prevent electrical shocks or fire.
- Securely fasten the outside unit terminal cover (panel). If the terminal cover/panel is not installed properly, dust or water may enter the outside unit causing fire or electric shock.
- When installing or relocating the system, keep the refrigerant circuit free from substances other than the specified refrigerant (R-410A) such as air. Any presence of air or other foreign substance in the refrigerant circuit can cause an abnormal pressure rise or rupture, resulting in injury.
- Do not change the setting of the protection devices. If the pressure switch, thermal switch, or other protection device is shorted and operated forcibly, or parts other than those specified by Daikin are used, fire or explosion may occur.



CAUTION

- Do not touch the switch with wet fingers. Touching a switch with wet fingers can cause electric shock.
- Do not allow children to play on or around the unit to prevent injury.
- Do not touch the refrigerant pipes during and immediately after operation as the refrigerant pipes may be hot or cold, depending on the condition of the refrigerant flowing through the refrigerant piping, compressor, and other refrigerant cycle parts. Your hands may suffer burns or frostbite if you touch the refrigerant pipes. To avoid injury, give the pipes time to return to normal temperature or, if you must touch them, be sure to wear proper gloves.
- Heat exchanger fins are sharp enough to cut. To avoid injury wear glove or cover the fins when working around them.
- Install drain piping to proper drainage. Improper drain piping may result in water leakage and property damage.
- Insulate piping to prevent condensation.
- Be careful when transporting the product.
- Do not turn off the power immediately after stopping operation. Always wait for at least 5 minutes before turning off the power. Otherwise, water leakage may occur.
- Do not use a charging cylinder. Using a charging cylinder may cause the refrigerant to deteriorate.
- Refrigerant R-410A in the system must be kept clean, dry, and tight.
 - (a) Clean and Dry -- Foreign materials (including mineral oils such as SUNISO oil or moisture) should be prevented from getting into the system.
 - (b) Tight -- R-410A does not contain any chlorine, does not destroy the ozone layer, and does not reduce the earth's protection against harmful ultraviolet radiation. R-410A can contribute to the greenhouse effect if it is released. Therefore take proper measures to check for the tightness of the refrigerant piping installation. Read the chapter Refrigerant Piping and follow the procedures.
- Since R-410A is a blend, the required additional refrigerant must be charged in its liquid state. If the refrigerant is charged in a state of gas, its composition can change and the system will not work properly.
- The indoor unit is for R-410A. See the catalog for indoor models that can be connected. Normal operation is not possible when connected to other units.
- Remote controller (wireless kit) transmitting distance can be shorter than expected in rooms with electronic fluorescent lamps (inverter or rapid start types). Install the indoor unit far away from fluorescent lamps as much as possible.
- Indoor units are for indoor installation only. Outdoor units can be installed either outdoors or indoors.

- Do not install the air conditioner in the following locations:
 - (a) Where a mineral oil mist or oil spray or vapor is produced, for example, in a kitchen. Plastic parts may deteriorate and fall off or result in water leakage.
 - (b) Where corrosive gas, such as sulfurous acid gas, is produced. Corroding copper pipes or soldered parts may result in refrigerant leakage.
 - (c) Near machinery emitting electromagnetic waves. Electromagnetic waves may disturb the operation of the control system and cause the unit to malfunction.
 - (d) Where flammable gas may leak, where there is carbon fiber, or ignitable dust suspension in the air, or where volatile flammables such as thinner or gasoline are handled. Operating the unit in such conditions can cause a fire.
- Take adequate measures to prevent the outside unit from being used as a shelter by small animals. Small animals making contact with electrical parts can cause malfunctions, smoke, or fire. Instruct the customer to keep the area around the unit clean.



NOTE

- Install the power supply and control wires for the indoor and outdoor units at least 3.5 feet away from televisions or radios to prevent image interference or noise. Depending on the radio waves, a distance of 3.5 feet may not be sufficient to eliminate the noise.
 - Dismantling the unit, treatment of the refrigerant, oil and additional parts must be done in accordance with the relevant local, state, and national regulations.
 - Do not use the following tools that are used with conventional refrigerants: gauge manifold, charge hose, gas leak detector, reverse flow check valve, refrigerant charge base, vacuum gauge, or refrigerant recovery equipment.
 - If the conventional refrigerant and refrigerator oil are mixed in R-410A, the refrigerant may deteriorate.
 - This air conditioner is an appliance that should not be accessible to the general public.
 - The wall thickness of field-installed pipes should be selected in accordance with the relevant local, state, and national regulations.
-

2. INTRODUCTION

This installation manual concerns VRV inverters of the Daikin RWEYQ-P series. These units are designed for indoor installation and used for cooling and heatpump applications.

The RWEYQ-P units can be combined with Daikin VRV series indoor units for air conditioning purposes.

The present installation manual describes the procedures for unpacking, installing and connecting the RWEYQ-P units. Installation of the indoor units is not described in this manual. Always refer to the installation manual supplied with these units for their installation.

2-1 Combination

The indoor units can be installed in the following range.

- **Always use appropriate indoor units compatible with R410A. To lean which models of indoor units are compatible with R410A, refer to the product catalogs.**

- Total capacity/quantity of indoor units
 (Outside unit) (Total capacity index of indoor units) (Total quantity of indoor units)
 RWEYQ72PTJU.....36 ~ 93.5 12 units
 RWEYQ84PTJU.....42 ~ 109 14 units
 RWEYQ144PTJU.....72 ~ 187 20 units
 RWEYQ168PTJU.....84 ~ 218 20 units
 RWEYQ216PTJU.....108 ~ 280 22 units
 RWEYQ252PTJU.....126 ~ 327.5 32 units

2-2 Standard operation limit

The figures below assume following operating conditions for indoor and outside units:

Equivalent pipe length25 ft
 Level difference0 ft

Cooling

Heating

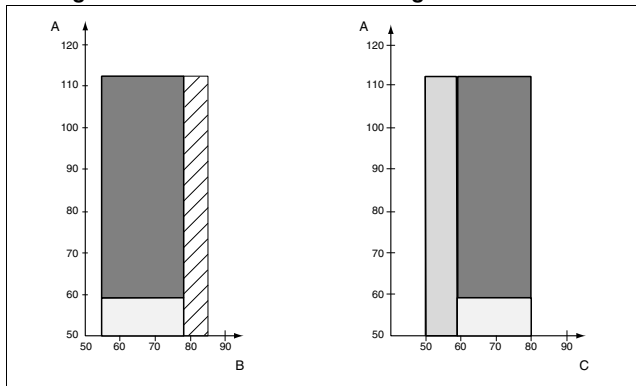

- A Inlet water temperature (°F)
- B Indoor temperature (°FWB)
- C Indoor temperature (°FDB)

- Range for continuous operation
- Range for operation
- ▨ Range for pull down operation
- ◐ Range for warming up operation

- Operation range of water volume is **13.5~39.5 gpm**
- **The unit is designed for the following operation range:**
Water temperature: 67~95°F
Water volume: 16 gpm or more
- During cooling operation when the outside temperature is very low, it is possible that the thermostat switches off automatically in order to protect the unit from freezing.
- Hold ambient temperature at 35~95°F
 Heat-release from the unit: 0.64 kW / hour (Model 72, 84).
 It is therefore recommended to always ventilate the room.

2-3 Standard supplied accessories

- Make sure that the following accessories are included. (Check by removing the front panel.)

Name	Accessory pipes				
	For discharge gas	For suction gas (1)	For suction gas (2)	Clamp (A)	Clamp (B)
Quantity	1 pc.	1 pc.	1 pc.	7 pcs.	2 pcs.
Shape	(Note)			White	Black
Name	Strainer	Conduit mounting plate		[Others] • Installation manual • Operation manual	
Quantity	1 pc.	2 pcs.	2 pcs.		
Shape					

(Refer to figure 1)

- Operation manual
 • Installation manual
 • Clamp (A)
 • Clamp (B)
 • Conduit mounting plate
- Accessory pipes
 • For discharge gas
 • For suction gas (1)
 • For suction gas (2)
- Strainer

⚠ NOTE

The accessory pipe for discharge gas is used for the heat recovery system. (Not used for the heat pump system.)

2-4 Option accessory

To install the above outside units, the following optional parts are also required.

- Refrigerant branching kit
 (For R410A only: Always use an appropriate kit dedicated for your system.)

〈Heat pump system〉

REFNET header	KHRP26M22H	KHRP26M33H	KHRP26M72H	KHRP26M73HU
REFNET joint	KHRP26M22T	KHRP26M33T	KHRP26M72TU	KHRP26M73TU

〈Heat recovery system.....For 3-tube piping〉

REFNET header	KHRP25M22H	KHRP25M33H	KHRP25M72H	KHRP25M73HU
REFNET joint	KHRP25M22T	KHRP25M33T	KHRP25M72TU	KHRP25M73TU

〈Heat recovery system.....For 2-tube piping〉

REFNET header	KHRP26M22H	KHRP26M33H	KHRP26M72H	KHRP26M73HU
REFNET joint	KHRP26M22T	KHRP26M33T	KHRP26M72TU	KHRP26M73TU

- Outside unit multi connection piping kit
 (For R410A only: Always use an appropriate kit dedicated for your system.)

Number of outside units connected	2 units	3 units
Heat pump system	BHFP22MA56U	BHFP22MA84U
Heat recovery system	BHFP26MA56U	BHFP26MA84U

* To select an optimum kit, refer to "9. REFRIGERANT PIPING"

2-5 Technical specifications ⁽¹⁾

General	RWEYQ72PTJU	RWEYQ84PTJU
Nominal cooling capacity (2) (MBh)	72	84
Nominal cooling capacity (3) (MBh)	81	94.5
Nominal input cooling / heating (4) (kW)	4.20 / 4.00	5.60 / 5.40
Dimensions HxWxD (inch)	39-3/8x30-3/4x21-11/16	
Weight (lbs)	330	330
Connections		
refrigerant liquid pipe (inch)	3/8	3/8
refrigerant gas pipe (inch)	3/4	7/8
refrigerant discharge gas pipe (5) (inch)	5/8	3/4
Water piping connections		
Inlet pipe (inch)	1-1/4FPT female Thread	1-1/4FPT female Thread
Outlet pipe (inch)	1-1/4FPT female Thread	1-1/4FPT female Thread
Drain pipe (inch)	1/2FPS female Thread	1/2FPS female Thread

General	RWEYQ144PTJU	RWEYQ168PTJU
Nominal cooling capacity (2) (MBh)	144	168
Nominal cooling capacity (3) (MBh)	162	189
Nominal input cooling / heating (4) (kW)	8.40 / 8.00	11.20 / 10.80
Dimensions HxWxD (inch)	(39-3/8x30-3/4x21-11/16)x2	
Weight (lbs)	330x2	330x2
Connections		
refrigerant liquid pipe (inch)	1/2	5/8
refrigerant gas pipe (inch)	1-1/8	1-1/8
refrigerant discharge gas pipe (5) (inch)	7/8	7/8
Water piping connections		
Inlet pipe (inch)	(1-1/4FPT)x2 female Thread	(1-1/4FPT)x2 female Thread
Outlet pipe (inch)	(1-1/4FPT)x2 female Thread	(1-1/4FPT)x2 female Thread
Drain pipe (inch)	(1/2FPS)x2 female Thread	(1/2FPS)x2 female Thread

General	RWEYQ216PTJU	RWEYQ252PTJU
Nominal cooling capacity (2) (MBh)	216	252
Nominal cooling capacity (3) (MBh)	243	283.5
Nominal input cooling / heating (4) (kW)	12.60 / 12.00	16.80 / 16.20
Dimensions HxWxD (inch)	(39-3/8x30-3/4x21-11/16)x3	
Weight (lbs)	330x3	330x3
Connections		
refrigerant liquid pipe (inch)	5/8	3/4
refrigerant gas pipe (inch)	1-1/8	1-1/4
refrigerant discharge gas pipe (5) (inch)	1	1-1/8
Water piping connections		
Inlet pipe (inch)	(1-1/4FPT)x3 female Thread	(1-1/4FPT)x3 female Thread
Outlet pipe (inch)	(1-1/4FPT)x3 female Thread	(1-1/4FPT)x3 female Thread
Drain pipe (inch)	(1/2FPS)x3 female Thread	(1/2FPS)x3 female Thread

- (1) Refer to the engineering data book for the complete list of specifications.
- (2) The normal cooling capacities are based on:
 -indoor temperature: 80 °FDB / 67 °FWB,
 -inlet water temperature: 85 °F,
 -outlet water temperature: 95 °F,
 -equivalent pipe length: 25 ft,
 -level difference: 0 ft
- (3) The normal heating capacities are based on:
 -indoor temperature: 70 °FDB / 60 °FWB,
 -inlet water temperature: 70 °F,
 -equivalent pipe length: 25 ft,
 -level difference: 0 ft
- (4) The nominal input includes total input of the unit: compressor and control circuit.
- (5) In case of heat recovery system

Compressor	RWEYQ72PTJU	RWEYQ84PTJU
Oil type	Synthetic (ether) oil	
Crankcase heater (W)	33	33
Refrigerant type	R410A	
Refrigerant charge (lbs)	9.9	11.5

Compressor	RWEYQ144PTJU	RWEYQ168PTJU
Oil type	Synthetic (ether) oil	
Crankcase heater (W)	(33)x2	(33)x2
Refrigerant type	R410A	
Refrigerant charge (lbs)	(9.9)x2	(11.5)x2

Compressor	RWEYQ216PTJU	RWEYQ252PTJU
Oil type	Synthetic (ether) oil	
Crankcase heater (W)	(33)x3	(33)x3
Refrigerant type	R410A	
Refrigerant charge (lbs)	(9.9)x3	(11.5)x3

2-6 Electrical specifications

Model	RWEYQ72PTJU	RWEYQ84PTJU
Power supply		
Phase	3~	3~
Frequency (Hz)	60	60
Voltage (V)	208-230	208-230
Voltage tolerance (%)	±10	±10
Recommended fuses (A)	40	40
Compressor		
Phase	3~	3~
Frequency (Hz)	60	60
Voltage (V)	208-230	208-230
Nominal running current (A)	11.6	15.4

Model	RWEYQ144PTJU	RWEYQ168PTJU
Power supply		
Phase	3~	3~
Frequency (Hz)	60	60
Voltage (V)	208-230	208-230
Voltage tolerance (%)	±10	±10
Recommended fuses (A)	(40)x2	(40)x2
Compressor		
Phase	3~	3~
Frequency (Hz)	60	60
Voltage (V)	208-230	208-230
Nominal running current (A)	(11.6)x2	(15.4)x2

Model	RWEYQ216PTJU	RWEYQ252PTJU
Power supply		
Phase	3~	3~
Frequency (Hz)	60	60
Voltage (V)	208-230	208-230
Voltage tolerance (%)	±10	±10
Recommended fuses (A)	(40)x3	(40)x3
Compressor		
Phase	3~	3~
Frequency (Hz)	60	60
Voltage (V)	208-230	208-230
Nominal running current (A)	(11.6)x3	(15.4)x3

3. SELECTION OF LOCATION

This unit does not have specifications for outdoor installation. The unit must be installed indoors (example: machine room, ...).

Paying attention to the conditions mentioned below, select the place for installation with a prior approval of customer.

1. The foundation is strong enough to support the weight of the unit and the floor is flat to prevent vibration and noise generation.
2. Consider the space required for refrigerant piping work when installing. Refer to [Necessary Space].
3. There is no danger of fire due to leakage of inflammable gas.
4. The piping length between the outside unit and the indoor unit may not exceed the allowable piping length. "9. REFRIGERANT PIPING".
5. Locations where the noise of the unit operating will not disturb nearby houses, etc.
6. Locations with airflow and ventilation holes capable of dissipating heat from the machine and where the ambient temperature around the outside unit is between 35 and 95 °F and the humidity does not exceed 80%.

[Necessary Space]

When installing, secure the space mentioned below without fail.

(Refer to figure 2)

1. In case of a single installation [inch.]
2. In case of series installations [inch.]
3. Top view
4. Side view
5. Outside unit
6. Service Space (front side)
7. Service Space (back side)
8. Space for installing water piping
*Secure a enough space for removing the front panel.
9. Ventilation Space
*above the area (:::;) of the outside unit.
10. Secure spaces in the front, back and top sides as same as the case of single installation.



DANGER

- Do not install unit in an area where flammable materials are present due to risk of explosion resulting in serious injury or death.
- Refrigerant is heavier than air and replaces oxygen. A massive leak could lead to oxygen depletion, especially in basements, and an asphyxiation hazard could occur leading to serious injury or death. Refer to the chapter "Caution for refrigerant leaks".



NOTE

1. An inverter air conditioner may cause electronic noise generated from AM broadcasting. Examine where to install the main air conditioner and electric wires, keeping proper distances away from stereo equipment, personal computers, etc.

(Refer to figure 3)

1. Indoor unit
2. Branch switch, overcurrent breaker
3. Remote controller
4. Cool/heat selector
5. Personal computer or radio

If the electric wave of AM broadcasting is particularly weak, keep distances of 10 ft or more and use conduit tubes for power and transmission lines.

2. Water quality
Water containing high level of foreign materials may cause the corrosion of heat exchanger and piping or scale accumulation. Use water satisfying "7-4 Water quality".
3. Cooling tower
Use a closed type cooling tower without fail. (Open type tower cannot be used.)
4. Strainer
Install the strainer (accessory) without fail at the inlet of water piping. (If sands, wastes, rust particles, etc. are mixed in the water circulation system, damage to the plate type heat exchanger may be caused by the corrosion of metal materials and clogging of the heat exchanger.)



WARNING



Do not install in the following locations.

- Locations such as kitchens which contain a lot of mineral oil or steam in the atmosphere or where oil may splatter on the unit.
Resin parts may deteriorate, causing the unit to fall or leak.
- Locations where sulfurous acids and other corrosive gases may be present in the atmosphere.
Copper piping and soldered joints may corrode, causing refrigerant to leak.
- Locations where equipment that produces electromagnetic waves is found.
The electromagnetic waves may cause the control system to malfunction, preventing normal operation.

4. INSPECTING AND HANDLING THE UNIT

At delivery, the package should be checked and any damage should be reported immediately to the carrier claims agent.

When handling the unit, take into account the following:

1.  Fragile, handle the unit with care.
 Keep the unit upright in order to avoid compressor damage.
2. Choose the path along which the unit is to be brought in ahead of time.
3. In order to prevent any damage to the unit during installation, use slings (cloth) or patch plates and lift the unit referring to figure 4.
4. Lift the unit preferably with a crane and 2 belts of at least 27 ft long.
5. When lifting the unit with a crane, always use protectors to prevent belt damage and pay attention to the position of the unit's center of gravity.
6. Be sure use the standard supplied accessories and dedicated parts as installation parts.
(Refer to figure 4)
 1. Patch plates or clothes
 2. Belt sling



NOTE

- Use belt sling of 13/16" width or less which adequately bears the weight of the product.

5. UNPACKING AND PLACING THE UNIT

- Make sure the area around the machine drains properly by setting up drainage grooves around the foundation.
- Make sure the unit is installed level on a sufficiently strong base to prevent vibration and noise.
- Secure the unit to its base using foundation bolts. (Use four commercially available M12-type foundation bolts, nuts, and washers.)
- The foundation bolts should be inserted 13/16".
- Fix 4 foundation bolts.
- Support the unit with the foundation which is larger than the hatched area shown in figure 5.

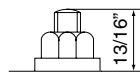

(Refer to figure 5)

1. Front side
2. Position of foundation bolts
3. Hole for a foundation bolt ($\phi 11/16$ in. holes at 4 corners)
4. Avoid such a foundation where the unit is supported by 4 corner points.



CAUTION

- When installing the unit closely contacting the wall for any unavoidable reason, arrange so that no vibration from the unit may be transmitted to the wall surface by insulating the vibration using cushions, etc.

NOTE

- Prepare a water drainage channel around the foundation to condensate waste water from around the unit.
- If the unit is to be installed on a roof, check the strength of the roof and its drainage facilities first.
- Make sure the area around the machine drains properly by setting up drainage grooves around the foundation.
(Condensate water is sometimes discharged from the outside unit when it is running.)
- Use a nut with a resin clip plate to protect the nut tightening part from rusting.

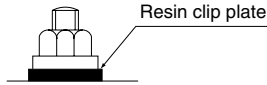

6. WATER PIPING WORK

- The water pressure resistance of water piping of this outside unit is 285 psi.
- The connection port for water piping is located in the front. The connection ports for drain piping are located in the front and back. When using the back port, change the cast iron plug from the back to the front and securely close it.
- Because of indoor use, carry out piping work in such a way no water may drop on the outer plate.
- Drain piping should be short and have a slant downwards. The diameter of drain pipe should be the same as the diameter of unit connection (1/2) or more.
- The diameter of water pipe should be the same as the diameter of unit connection (1-1/4) or more.
- Install an air purge valve in the midway of the water piping to prevent cavitation.
- After completing the drain piping work, make sure that the water runs smoothly without any clogging by dust.
- Do not connect the drain outlet to the water outlet.
- Install the strainer (accessory) in the inlet of water piping within a distance of 4.9 ft from the outside unit.
(If sand, waste or rust particles are mixed in the water circulation system, metal materials will become corrosive.)
- Install insulation on the inlet/outlet of water piping to prevent condensation and freezing.
At installing insulation on water in/outlet pipe, use Polyurethane form thickness 3/16 in. for insulation of water piping socket on heat exchanger.
- Install insulation up to the base of heat exchanger as shown in the figure 6.
- Install a gate valve for chemical cleaning in an easy position to handle.
- Use water pipes complied with the local and national codes.
- Run the water pump to flush inside of water piping. Then, clean the strainer.
- If there is a possibility of freezing, take measures to prevent freezing.
- Tighten securely the connection of water piping and socket with tightening torque of 220 lbf-ft or less.
(If a large torque is applied, the unit may be damaged.)

(Refer to figure 6)

1. Air purge
2. Outlet of water
3. Inlet of water
4. Gate valve
5. Water piping socket
6. Water piping
7. Insulation
8. Heat exchanger
9. Strainer (accessory)
10. Drain valve
11. Connection port to draining piping
12. Insulation cover
13. 3-1/8 in. or less
14. Insulation of water piping socket

7. HANDLING OF THE BRAZED PLATE TYPE HEAT EXCHANGER

CAUTION

A brazed plate type heat exchanger is used for this unit. Because its structure is different from a conventional type heat exchanger, it must be handled in a different manner.

7-1 When designing the equipment

1. Install the strainer (accessory) at the water inlet side adjacent to the outside unit in order to prevent any foreign materials such as dust, sand, etc. from entering.
2. Depending on the water quality, scale may stick to the plate type heat exchanger. In order to remove this scale, it is necessary to clean it at a regular interval using chemicals. To this end, install a gate valve in the water piping. Set up a piping connection port on the piping between this gate valve and the outside unit for cleaning by chemicals.
3. For the purpose of cleaning and water drain off from the outside unit (water draining during a long period of non-use in winter, draining upon starting of season-off), install an "air discharge plug" and a "water draining plug" at the inlet/outlet ports of water piping. In addition, install an "automatic air discharging valve" at the top of riser piping or at the top of a portion where air tends to stay.
4. Independent of the piping inlet of the outside unit, install a cleanable strainer at a portion close to the pump piping inlet.
5. Carry out complete cooling/thermal insulation of water piping and outdoor dehumidification. If complete cooling or thermal insulation has not been carried out, any damage may be caused during severe winter due to freezing, in addition to thermal loss.
6. When you stop operation during night or winter, it is necessary to take measures to prevent water related circuits from natural freezing in the area the ambient temperature drops below 32°F (by water drain off, keeping the circulation pump running, warming up by a heater, etc.) Freezing of water related circuits may result in any damage to the plate type heat exchanger. Therefore, please take appropriate measures depending on the circumstances of use.

(Refer to figure 7)

1. Example of piping
2. Water inlet piping
3. Strainer (accessory)
4. Air discharge plug (for joint use with cleaning port)
5. Cleaning device
6. Strainer for pump
7. Automatic air discharge valve
8. Water outlet piping
9. Joint use with water draining plug
10. Plate type heat exchanger
11. Outside unit

7-2 Before starting a test run

1. Before starting a test run, please make sure that the piping work has been carried out in a proper manner. Especially, make sure that the strainer, air discharge valve, automatic water supply valve, expansion tank and cistern are positioned at their places correctly.
2. After water has been completely filled in, first run the pump only, and then make sure that no air has been caught in the water circulation system and the water flow rate is correct. If any air has been caught or the flow rate is not enough, the plate type heat exchanger may freeze. Measure any water pressure loss before and after the outside unit and make sure that the flow rate is as designed. In case of any abnormal, stop the test run immediately and carry out trouble shooting to resolve the trouble.
3. Following the installation manual, carry out a test run of the outside unit.
4. After the test run has been completed, inspect the strainer at the inlet piping of the outside unit. Clean it if it is dirty.

7-3 Daily service and maintenance

1. Management of water quality

The plate type heat exchanger has a structure that does not permit dismantling and cleaning, or replacing any parts. Please pay attention carefully to the quality of water to be used for the plate type heat exchanger in order to prevent corrosion and sticking of scale.

The water to be used for the plate type heat exchanger should have at least the quality as specified in the table below.

When using any corrosion prevention agent, scale depressant agent, etc, such agent should have no corrosive features against stainless steel and copper.

2. Management of chilled water flow rate

If the chilled water flow rate is not enough, it will result in the freezing damage to the plate type heat exchanger. Check for any clogging of the strainer, any air being caught, any reduction in the flow rate due to failure of circulation pump by measuring the temperature and pressure differences at the inlet and outlet ports of the plate type heat exchanger. If the aged difference in the temperature or pressure has increased beyond the proper range, the flow rate should have decreased. Stop the operation and remove the cause before restarting the operation.

3. Steps to be taken when a freezing protection device was activated

When the freezing protection device should be activated during operation, remove the cause without fail before restarting the operation. If the freezing protection device has been once activated, a partial freezing has occurred. If you restart the operation without removing the cause, the plate type heat exchanger will be closed and the ice cannot be melted, and in addition, the freezing process will be repeated resulting in any damage to the plate type heat exchanger, leading to any such accidents that the refrigerant starts leaking or water starts entering the refrigerant circuit.

7-4 Water quality

Water quality standards for chilled water, hot water and make-up water (4) (6)

Item (5)	Cooling water system (3)		Hot water system (2)		Tendency (1)	
	Circulation system		Circulation water (68°F - 140°F)	Make-up water	Corrosion	Scale
	Circulation water	Make-up water				
Standard items						
pH (77°F)	6.5 to 8.2	6.0 to 8.0	7.0 to 8.0	7.0 to 8.0	○	○
Electrical Conductivity (mS/ft)(77°F)	Less than 24.4	Less than 9.1	Less than 9.1	Less than 9.1	○	○
Chloride ions (mgCl/L)	Less than 200	Less than 50	Less than 50	Less than 50	○	
Sulfate ions (mgSO ₄ ²⁻ /L)	Less than 200	Less than 50	Less than 50	Less than 50	○	
Acid consumption (pH4.8) (mgCaCO ₃ /L)	Less than 100	Less than 50	Less than 50	Less than 50		○
Total hardness (mgCaCO ₃ /L)	Less than 200	Less than 70	Less than 70	Less than 70		○
Calcium hardness (mgCaCO ₃ /L)	Less than 150	Less than 50	Less than 50	Less than 50		○
Ionic-state silica (mgSiO ₂ /L)	Less than 50	Less than 30	Less than 30	Less than 30		○
Reference items						
Iron (mgFe/L)	Less than 1.0	Less than 0.3	Less than 1.0	Less than 0.3	○	○
Copper (mgCu/L)	Less than 0.3	Less than 0.1	Less than 1.0	Less than 0.1	○	
Sulfate ion (mgS ²⁻ /L)	Shall not be detected	Shall not be detected	Shall not be detected	Shall not be detected	○	
Ammonium ion (mgNH ₄ ⁺ /L)	Less than 1.0	Less than 0.1	Less than 0.3	Less than 0.1	○	
Residual chlorine (mgCl/L)	Less than 0.3	Less than 0.3	Less than 0.25	Less than 0.3	○	
Free carbon dioxide (mgCO ₂ /L)	Less than 4.0	Less than 4.0	Less than 0.4	Less than 4.0	○	
Stability index	6.0 to 7.0	—	—	—	○	○

[NOTES]

- The circle marks in the columns for corrosion or scale to develop.
- Corrosion has a tendency to occur when water temperature is high (104 °F or more), and if metals with no protective coating whatever are directly exposed to water, it would be a good idea to take effective measures against corrosion such as adding a corrosion inhibitor or deaeration treatment.
- In a condenser water circuit that uses a closed cooling tower, the closed circuit circulating water and make-up water must satisfy its water quality standards for the hot water system, and passing water and make-up water must satisfy those for the circulation type cooling water system.
- The supply water must be clean tap water, industrial water or clean underground water.
Do not use purified or softened water.
- The fifteen items in the table above represent typical causes of corrosion and scale.
- Once through water may cause corrosion.
Do not use once through water.

7-5 Maintenance of plate type heat exchanger

The performance of a plate type heat exchanger may decline due to scale accumulation. It may be damaged by freezing due to the drop of flow rate. For this reason, it is necessary to carry out programmed maintenances at a regular interval in order to prevent the scale from being generated.

1. Before entering the season for use, carry out the following inspections:

- Conduct a water quality test and make sure that it is within the standard.
- Clean the strainer.
- Make sure that the flow rate is correct.
- Make sure that the operational conditions (pressure, flow rate, outlet temperature, etc.) are normal.

2. Because the plate type heat exchanger has a structure which does not permit disassembling and cleaning, follow the following procedures for cleaning:

- For maintenance purposes it is required to provide for a connection port on the water inlet and on the water outlet. You must connect a circulation pump inbetween these 2 connection ports when cleaning the plate heat exchanger with chemicals.

For cleaning the scale in the plate heat exchanger it is recommended to use a solution with 5% diluted formic, citric, oxalic, acetic or phosphoric acid.

Never use hydrochloric, sulfuric or nitric acid because such solutions have a strong corrosive feature.

- Make sure to provide for a stopvalve in front of that inlet water pipe connection port and for a stopvalve after the outlet water pipe connection port.
- Connect the piping for circulation of cleaning chemicals to the inlet and outlet piping of plate type heat exchanger. Fill the cleaning solution of 122 - 144 °F for a while in the plate type heat exchanger. Then, circulate the cleaning solution by a pump for 2-5 hours.

The time for cleaning depends on the temperature of cleaning solution or the degree of scale accumulation. Therefore, please watch the change of the dirtiness (color) of cleaning solution to determine the level of removal of scale.

- After circulating the cleaning solution, discharge the solution from the plate type heat exchanger, fill the heat exchanger with a solution of 1-2% sodium hydroxide (NaOH) or sodium bicarbonate (NaHCO₃). Circulate this solution for 15-20 minutes for neutralization purpose.
 - After the process of neutralization has been completed, rinse the inner part of the plate type heat exchanger with care using fresh and clean water.
 - When using any cleaning agent sold in the market, check in advance that such agent has no corrosive features against stainless steel and copper.
 - For details of cleaning method, ask the manufacturer of related cleaning agent.
3. After cleaning has been completed, make sure that the unit can be operated in a normal fashion.

8. FIELD WIRING



NOTE

- All field wiring and components must be installed by a licensed electrician and must comply with relevant local and national regulations.
- The field wiring must be carried out in accordance with the wiring diagrams and the instructions given below.
- Be sure to use a dedicated power circuit. Never use a power supply shared by another appliance.
- Do not operate until refrigerant piping work is completed. (If operated before complete the piping work, the compressor may be broken down.)
- Never remove thermistor, sensor or etc. when connecting power wiring and transmission wiring. (If operated with thermistor, sensor or etc. removed, the compressor may be broken down.)
- Be sure to install a ground fault circuit interrupter. (This unit uses an inverter, so install a ground fault circuit interrupter that be capable of handling high harmonics in order to prevent malfunctioning of a ground fault circuit interrupter itself.)
- This product have reversed phase protection detector only works when the product started up.
- Replace two of the three phases (L1, L2, and L3) during reverse-phase protection circuit operation. Reversed phase detection is not performed while the product is operating.
- Do not run the unit by short cutting the protection device (S1PH). If there exists the possibility of reversed phase, lose phase, momentary black out or the power goes on and off while the product is operating, attach a reversed phase protection circuit locally. Running the product in reversed phase may break the compressor and other parts.
- Attach the power wire securely.

8-1 Optional parts

COOL/HEAT Selector

S1S.....Selector switch (fan, cool/heat)

S2S.....Selector switch (cool/heat)

NOTE

- Use copper conductors only.
- When using the adaptor for sequential start, refer to chapter “Examples”.
- For connection wiring to outdoor-outdoor transmission F1-F2, outdoor-indoor transmission F1-F2, refer to chapter “Examples”.
- For connection wiring to the central remote controller, refer to the installation manual of the central remote controller.
- Use insulated wire for the power cord.

8-2 Power circuit and cable requirements

A power circuit (see table below) must be provided for connection of the unit. This circuit must be protected with the required safety devices, i.e. a main switch, a slow blow fuse on each phase and a ground fault circuit interrupter.

	Phase and frequency	Voltage	Minimum circuit amp.	Recommended fuses	Transmission line selection
RWEYQ72/84PTJU	φ 3, 60 Hz	208-230V	22.4A	40A	AWG18-16
RWEYQ144/168PTJU	φ 3, 60 Hz	208-230V	44.8A	40+40A	AWG18-16
RWEYQ216/252PTJU	φ 3, 60 Hz	208-230V	67.1A	40+40+40A	AWG18-16

NOTE

- Select the power supply cable in accordance with relevant local and national regulations.
- Wire size must comply with the applicable local and national code.
- Specifications for local wiring power cord and branch wiring are in compliance with local cord.

8-3 General

- Make sure to connect the power source wire to the power source terminal block and to clamp it as shown in figure 8, chapter “Field line connection”.
- As this unit is equipped with an inverter, installing a phase advancing capacitor will not only reduce the power factor improvement effect, but also may cause the capacitor to overheat due to high-frequency waves. Therefore, never install a phase advancing capacitor.
- Keep power imbalance within 2% of the supply rating.
 1. Large imbalance will shorten the life of the smoothing capacitor.
 2. As a protective measure, the product will stop operating and an error indication will be made, when power imbalance exceeds 4% of the supply rating.
- Follow the “electrical wiring diagram” when carrying out any electrical wiring.
- Only proceed with wiring work after blocking off all power.
- Always ground wires. (In accordance with national regulations of the pertinent country.)
- This unit uses an inverter, and therefore generates noise, which will have to be reduced to avoid interfering with other devices. The outer casing of the product may take on an electrical charge due to leaked electrical current, which will have to be discharged with the grounding.
- This unit has a negative phase protection circuit. (If it operates, only operate the unit after correcting the wiring.)



WARNING

- Do not ground units to gas pipes, sewage pipes, lightning rods, or telephone ground wires because incomplete grounding could cause a severe shock hazard resulting in severe injury or death.
 - Gas pipes:** can explode or catch fire if there is a gas leak.
 - Sewage pipes:** no grounding effect is possible if hard plastic piping is used.
 - Telephone ground wires and lightning rods:** dangerous when struck by lightning due to abnormal rise in electrical potential in the grounding.

8-4 Examples

System example (Refer to figure 8)

1. Field power supply
2. Main switch
3. Disconnect switch
4. Fuse
5. Ground fault circuit interrupter
6. Remote controller
7. Outside unit
8. BS unit
9. Indoor unit
10. Cool / heat selector
 - power supply wiring (sheathed cable)
 - transmission wiring (sheathed cable)



CAUTION

- Use a power wire pipe for the power wiring.
- Outside the unit, make sure the low-voltage electric wiring (i.e. for the remote controller, transmission, etc.) and the high-voltage electric wiring do not pass near each other, keeping them at least 5 in. apart. Proximity may cause electrical interference, malfunctions, and breakage.
- Be sure to connect the power wiring to the power wiring terminal block and secure it as described in **Field line connection**.
- Transmission wiring should be secured as described in **Field line connection**.
- Secure the wiring with the accessory clamps so that it does not touch the piping.
- Make sure the wiring and the electrical components box lid do not stick up above the structure, and close the cover firmly.



WARNING

- Never connect power supply wiring to the terminal block for remote controller wiring as this could damage the entire system.

Picking power line and transmission line

(Refer to figure 9)

1. Power supply wiring and wiring for pump operation (High voltage)
2. Connection wiring (Low voltage)
3. Set apart

Connect the wire to the terminal block on PC board with care since too much pressure may cause breakage of the PC board.

Field line connection: transmission wiring, interlock circuit, pump operation output and COOL/HEAT selector

Power and transmission line: Connect it using conduit mounting plates.

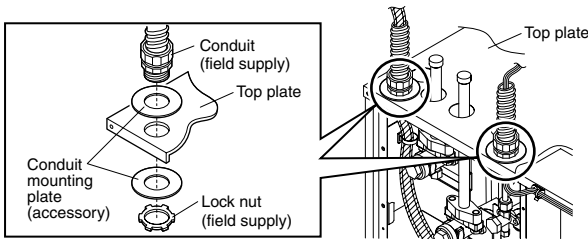

[In case of single outside unit]

(Refer to figure 10)

1. COOL/HEAT selector
2. Outside unit PC board (A1P)
3. Take care of the polarity
4. Use the conductor of sheathed wire (2 wire)(no polarity)
5. Terminal board (field supply)
6. Indoor unit
7. Never connect the power wire.
8. BS unit A
9. BS unit B
10. Last BS unit
11. Cool-only unit

[In case of multiple outside units]

(Refer to figure 11)

1. Unit A (Master unit)
 2. Unit B
 3. Unit C
 4. TO IN/D UNIT
 5. TO OUT/D UNIT
 6. TO MULTI UNIT
 7. To COOL/HEAT selector (only Heat pump system)
 8. To indoor unit
 9. To other systems
- The transmission wiring between the outside units in the same pipe line must be connected to the Q1/Q2 (Out Multi) terminals. Connecting the wires to the (Out-Out) terminals results in system malfunction.
 - The wiring for the other lines must be connected to the F1/F2 (Out-Out) terminals of the PC board in the outside unit to which the transmission wiring for the indoor units is connected.
 - The outside unit to which the transmission wiring for the indoor units is connected is master unit.
 - The transmission wiring between the outside units must be 100 ft. in length at maximum.

NOTE

- Be sure to keep the power line and transmission line apart from each other.
Be careful about polarity of the transmission line.
Make sure that the transmission line is clamped as shown in the figure in chapter "Field line connection".
Check that wiring lines do not make contact with refrigerant piping.
Firmly close the lid and arrange the electric wires so as to prevent the lid or other parts from coming loose.

[Setting the interlock circuit and pump operation output.]

(Pump operation output [high voltage])

- Use insulated wires of the size as mentioned below having rated voltage of 250 V or more:
For single core: AWG16 or larger (conduit pipe work)
For multiple cores: AWG18 or larger
- *The wiring for pump operation output is to be procured locally.

(Refer to figure 12)

1. Pump operation output terminal (X2M).
When water pump is linked with system operation, water pump operation circuit shall be set between terminals (1) and (2).
Contact specification --- 220 VAC, 3mA-0.5A

2. PC board (A1P)
3. Mount an insulation sleeve.
4. **Connection of interlock circuit**

Do not forget to connect an interlock circuit (an auxiliary a-contact of electromagnetic switch for the water pump) to each outside unit.
(Select without fail an auxiliary a-contact able to switch minimum load of DC15V, 1mA.)

◁When connecting for each outside unit
Connect to the terminal block (X3M) as shown in the bottom right of the sketch.

◁When connecting multiple outside units as 1 single unit (centralized interlock)
For this unit, it is possible to make a centralized interlock of multiple outside units using an adapter (sold separately as an accessory) for external control of outside units.
For details of wiring connection, refer to "How to centralized interlock wiring".

◁How to the centralized interlock wiring

- When centralized interlock is done, see "8-5 In case of a local setting" -(3)
- No wiring to terminal block X3M is necessary when centralized interlock is employed
- For multiple outside units, external/external connection wiring shall be done for master unit only.

(Refer to figure 13)

1. Outside unit A
2. Outside unit B
3. Outside unit C
4. Adapter for external control
5. Interlock circuit of water pump
6. Out-Out connection wiring
7. Use the conductor of sheathed wire (2 wire)(no polarity)

[Setting the cool/heat operation type]

1. Performing cool/heat setting with the remote controller connected to the indoor unit.
Keep the COOL/HEAT selector switch (DS1) on the outside unit PC board (A1P) at the factory setting position OFF.

(Refer to figure 16)

1. Remote controller
2. Performing cool/heat setting with the COOL/HEAT selector.
Connect the COOL/HEAT selector (optional) to the A/B/C terminals and set the COOL/HEAT selector switch (DS1) on the outside unit PC board (A1P) to ON.

(Refer to figure 17)

1. COOL/HEAT selector
- The wiring from the indoor units must be connected to the F1/F2 (In-Out) terminals on the PC board in the outdoor unit.
 - For the above wiring, always use sheathed vinyl cords with AWG18-16 sheath or cables (2 core wires). (3 core wire are allowable for the COOL/HEAT selector only.)

NOTE

- All transmission wire is field supply.
- Be sure to follow the limits below. If the transmission wiring is beyond these limits, it may result in malfunction of transmission.
Maximum wiring length: 3280 ft.
Total wiring length: 6560 ft.
Max. branches No. of branches: 16
Wire length between outside units:98 ft.

Up to 16 branches are possible for transmission wiring. No branching is allowed after branching.

Never connect the power supply to transmission wiring terminal block. Otherwise the entire system may break down.

(Refer to figure 14)

1. Branch
2. Subbranching

For low-noise operation, it is necessary to get the optional "External control adaptor for outdoor unit".
For details, see the installation manual attached to the adaptor.

Field line connection:

L1, L2, L3, phase of the power supply wiring should be clamped to the safety catch using the included clamp material. The green and yellow striped wrapped wires should be used for grounding. Make sure to connect the power wire to the power terminal block and fix it using attached clamp as shown in figure 15 and 19.

(Refer to figure 15)

1. Power supply (208-230V, Three-phase)
2. Branch switch, overcurrent breaker
3. Grounding wire
4. Ground fault circuit interrupter
5. Attach insulation sleeves.
6. Power supply terminal block
7. Grounding terminal
8. Retain the ground wires along with the power wires using the accessory clamp (A).
9. Grounding wire
10. When wiring, do not allow the ground wires to contact the compressor lead wires. If the wires contact each other, adverse effects may occur to other units.
11. When connecting two wires to one terminal, ensure that the crimp-style terminals face with each other back to back. Moreover, make sure that the wire of the smaller gauge is located above.
12. Terminal block
13. Crimp-style terminal
14. Wire gauge: Small
15. Wire gauge: Large

(Refer to figure 19)

1. Intake for power supply wiring, pump operation output (high voltage) and ground wiring.
2. Stop valve for discharge gas (high temperature part)
3. Insert the accessory clamp (B) in the hole of the fixing plate for stop valve.
4. Power supply wiring, pump operation output (high voltage) and ground wiring.
5. Retain the power supply wiring, pump operation output (high voltage) and ground wiring with the accessory clamp (B) to prevent them from touching with the stop valve for discharge gas.
6. Insert the accessory clamp (B) in the hole of the bottom of electrical box.
7. Intake for transmission wiring. (low voltage)
8. Make sure to provide for a downward loop in the transmission wiring right in front of the location where the wiring is to be fixed over the topplate of the switch box. This in order to prevent that condensate drips off the wiring into the switch box.
9. Fix the transmission wiring to resin clamps with the accessory clamps (A)
10. Pass the transmission wiring (low voltage) through the wire clip.
11. Retain the power supply wiring, pump operation output (high voltage) and ground wiring to the bottom of electrical box with the accessory clamp (B)

WARNING

- Use only specified wire and connect wires to terminals tightly. Be careful that wires do not place external stress on terminals. Keep wires in neat order so as not to obstruct other equipment. Incomplete connections could result in overheating, and in worse cases, electric shock or fire.

CAUTION

(Precautions when laying power wiring)

Use round pressure terminals for connections to the power terminal block.

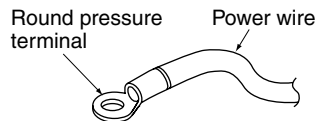

When none is available, follow the instructions below.

- Do not connect wiring of different thicknesses to the power terminal block. (Slack in the power wiring may cause abnormal heat.)
- When connecting wiring which is the same thickness, do as shown in the figure below.

Connect same-thickness wiring to both sides.

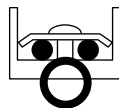

It is forbidden to connect two to one side.

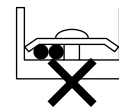

It is forbidden to connect wiring of different thicknesses.

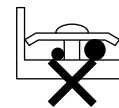

- For wiring, use the designated power wire and connect firmly, then secure to prevent outside pressure being exerted on the terminal board.
- Use an appropriate screwdriver for tightening the terminal screws. A screwdriver with a small head will strip the head and make proper tightening impossible.
- Over-tightening the terminal screws may break them.
- See the table below for tightening torque for the terminal screws.

	Tightening torque (ft · lbf)
M5 (Power terminal block)	2.21-3.02
M5 (Ground)	
M3 (Transmission wiring terminal block)	0.59-0.72

(Precautions when connecting the ground)

When pulling the ground wire out, wire it so that it comes through the cut out section of the cup washer. (An improper ground connection may prevent a good ground from being achieved.)

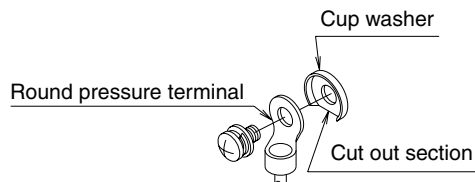

8-5 In case of a local setting

If necessary, do the local settings as mentioned in the table below. For setting, refer to the plate "Cares to be taken in servicing" attached to the cover of electrical components box.

Typical local settings

* For other settings than mentioned in the table below, refer to the equipment design materials and service manual.

(1) Setting of switching between cooling and heating	This setting is done when switching between cooling and heating is performed by a switching remote controller (sold separately as an accessory) installed on the outside unit.
(2) Setting to prohibit sequenced start	This setting is done when the outside units are not started in a sequenced order.
(3) Setting of centralized interlock Setting of external demand	These settings are done when the interlocks are connected in a lump-sum manner or when performing a demand operation by external instruction.
(4) Setting of abnormal display when interlock contact is OFF	This setting is done when making an abnormal display (HJ) on a remote controller when the interlock contact is OFF (when the heat source water pump is not operated).

CAUTION

A separate adapter (sold separately as an accessory) for external control of an outside unit is necessary when doing a demand operation from an external instruction, setting of cooling and heating through a centralized remote controller for cooling and heating (sold separately as an accessory) and setting of centralized interlock. For details, refer to the manual attached to the adapter.

9. REFRIGERANT PIPING

CAUTION

After completing installation, be sure to open the valves. (See 9-9 Additional refrigerant charge for details.) (Operating the unit with the valves shut will break the compressor.)

Use R410A to add refrigerant. (The R410A refrigerant cylinder has a pink stripe painted around it.)

All field piping must be installed by a licensed refrigeration technician and must comply with relevant local and national regulations.

CAUTION TO BE TAKEN WHEN BRAZING REFRIGERANT PIPING

Do not use flux when brazing copper-to-copper refrigerant piping. (Particularly for the HFC refrigerant piping.) Therefore, use the phosphor copper brazing filler metal (BCuP-2: JIS Z 3264/B-Cu93P-710, 795: ISO 3677) which does not require flux. (Flux has an extremely negative effect on refrigerant piping systems. For instance, if the chlorine based flux is used, it will cause pipe corrosion or, in particular, if the flux contains fluorine, it will damage the refrigerant oil.)

NOTE

- Installation tools:

Gauge manifold, charge hose, etc.

Make sure to use installation tools that are exclusively used for R410A installations to withstand the pressure and to prevent foreign materials (e.g. mineral oils such as SUNISO and moisture) from mixing into the system.

(The screw specifications differ for R410A and R407C.)

Vacuum pump

- Use a 2-stage vacuum pump with a non-return valve.
- Make sure the pump oil does not flow oppositely into the system while the pump is not working.
- Use a vacuum pump which can evacuate to -14.6 psi.

9-1 Selection of piping material

- Foreign materials inside pipes (including oils for fabrication) must be 9 mg/10 ft or less.
- Use the following material specification for refrigerant piping:
 - Construction material: Phosphoric acid deoxidized seamless copper for refrigerant.
 - Size: Determine the proper size referring to chapter "Example of connection".
 - The wall thickness of the refrigerant piping should comply with relevant local and national regulations. For R410A the design pressure is 450 psi.
- Make sure to use the particular branches of piping that have been selected referring to chapter "Example of connection".
- Refer to chapter "Stop valve operation procedure" in 9-10 about the stop valve operation procedure.
- Make sure to perform the piping installation within the range of the maximum allowable pipe length, allowable level difference and allowable length after branching as indicated in chapter "Example of connection".
- For installation of the refrigerant branching kit, refer to the installation manual delivered with the kit. And follow the conditions listed below.
 - Mount the REFNET joint so that it branches either horizontally or vertically.
 - Mount the REFNET header so that it branches horizontally. (Refer to figure 22)
 - Horizontal connections
 - Up to $\pm 30^\circ$ or vertically
 - Horizontal connections
- To connect the piping between outside units, an optional piping kit (multi connection piping kit) is always required. When installing the piping, follow the instructions in the installation manual that comes with the kit.

Restriction for the installation of the outside unit multi connection piping kit

- Install the joint horizontally within a lean of $\pm 15^\circ$ with caution nameplate on top. Refer to figure 23 (Fig. A)
Do not connect it vertically. Refer to figure 23 (Fig. B)
- Reserve the straight part of 19-11/16 in. or more to the branch pipe and do not bend the local pipe in that area. Straight part of 19-11/16 in. or more can be reserved if a local pipe (straight pipe) of 4-3/4 in. or more is connected to the joint. Refer to figure 23 (Fig. C)

- Incorrect installation may cause breakage of outside unit.

(Refer to figure 23)

- Caution nameplate
- Horizontal line
- Ground
- Straight part of 19-11/16 in. or more
- Local pipe (4-3/4 in. length or more)

Precautions when selecting branch piping.

- If the overall equivalent length of piping between the outside units and indoor units is 262.5 ft or more, be sure to enlarge the main pipe in the liquid-side branch piping.

Depending on the length of the refrigerant piping, the cooling/heating capacity may drop, but even in such cases it is ok to enlarge the main pipe.

(Refer to figure 21)

- Outside unit
- Main pipe
- Enlarge
- The first refrigerant branching kit.
- Indoor unit

[Liquid side]

RWEYQ72/84PTJU type: $\phi 3/8'' \rightarrow \phi 1/2''$

RWEYQ144PTJU type: $\phi 1/2'' \rightarrow \phi 5/8''$

RWEYQ168/216PTJU type: $\phi 5/8'' \rightarrow \phi 3/4''$

RWEYQ252PTJU type: $\phi 3/4'' \rightarrow \phi 7/8''$

9-2 Protection against contamination when installing pipes

- Take measures to prevent foreign materials like moisture and contamination from mixing into the system.

Place	Installation period	Protection method
Outdoor	More than a month	Pinch the pipe
	Less than a month	Pinch or tape the pipe
Indoor	Regardless of the period	

- Great caution is needed when passing copper tubes through walls.

9-3 Pipe connection

- Only use the flare nuts included with the unit. Using different flare nuts may cause the refrigerant to leak.
- Be sure to perform a nitrogen blow when brazing. (Brazing without performing nitrogen replacement or releasing nitrogen into the piping will create large quantities of oxidized film on the inside of the pipes, adversely affecting valves and compressors in the refrigerating system and preventing normal operation.)
- Do not use a flux when brazing the refrigerant pipe joints. Use phosphor copper brazing (B-Cu93P-710/795: ISO 3677) which does not require flux. (Flux has an extremely negative effect on refrigerant piping systems. For instance, if chlorine based flux is used, it will cause pipe corrosion. If the flux contains fluorine, it will damage the refrigerant oil.)

DANGER

- Use of oxygen could cause an explosion resulting in severe injury or death. Only use nitrogen gas.
- Refrigerant gas may produce toxic gas if it comes in contact with fire such as from a fan heater, stove or cooking device. Exposure to this gas could cause severe injury or death.

NOTE

- The pressure regulator for the nitrogen released when doing the brazing should be set to 2.9 psi or less.

(Refer to figure 18)

- Refrigerant piping
- Location to be brazed
- Nitrogen
- Taping
- Manual valve
- Regulator

Precautions when connecting pipes

- See the following table for flare part machining dimensions.
- When connecting the flare nuts, apply refrigerant oil to the inside of the flares and turn them three or four times at first. (Use ester oil or ether oil.)
- See the following table for tightening torque. (Applying too much torque may cause the flares to crack.)
- After all the piping has been connected, check the gas leak with nitrogen.

pipe size (in.)	tightening torque (ft. · lbf)	A (in.)	flare shape
φ 3/8"	24.1 - 29.4	0.504 - 0.520	
φ 1/2"	36.5 - 44.5	0.638 - 0.654	
φ 5/8"	45.6 - 55.6	0.760 - 0.776	

—Not recommendable but in case of emergency

You must use a torque wrench but if you are obliged to install the unit without a torque wrench, you may follow the installation method mentioned below.

After the work is finished, make sure to check that there is no gas leak.

When you keep on tightening the flare nut with a spanner, there is a point where the tightening torque suddenly increases. From that position, further tighten the flare nut the angle shown below:

(Unit: in.)

Pipe size	Further tightening angle	Recommended arm length of tool
φ 3/8"	60 to 90 degrees	Approx. 7-7/8
φ 1/2"	30 to 60 degrees	Approx. 9-13/16
φ 5/8"	30 to 60 degrees	Approx. 11-13/16
φ 3/4"	20 to 35 degrees	Approx. 17-3/4

9-4 Connecting the refrigerant piping

Connect piping to outside unit by using accessory pipes (Refer to figure 20)

1. Gas side piping
2. (field supply)
3. Gas side accessory pipe (for suction gas (1))
4. Liquid side pipe (field supply)
5. Flare nut (Included in the unit)
6. Accessory pipes (for discharge gas and suction gas (2)) is not used.
7. Piping on discharge gas side (field supply)
8. Piping on suction gas side (field supply)
9. Cut off the hatched area and use it as a cover for the drilled.
10. Hatched area
11. Accessory pipe (for discharge gas)
12. Accessory pipe (for suction gas)
13. Guideline for pipe machining
14. Accessory pipe (for suction gas (2))
15. Brazing
16. Accessory pipe (for suction gas (1))
17. Before fitting to the product, apply brazing.

NOTE

- Be sure to use the attached pipe when carrying out piping work in the field.
- Be sure that the local piping does not touch other pipes, the bottom panel or side panel. Especially for the bottom and side connection, be sure to protect the local piping with the provided insulation, to prevent it from coming into contact with the casing.

Precautions for installation of units

NOTE

- The outside unit multi connection piping kit that is sold separately as an option (BHFP22MA56U + 84U, BHFP26MA56U + 84U) is necessary for the multi installation of outside units.
- See the installation manual attached to the kit with attention to installation restrictions described in "connecting the refrigerant piping" when installing.

(Cautions for installation of multiple outdoor units)

1. The piping between the outdoor units must be routed level or slightly upward to avoid the risk of oil detention to the piping side.

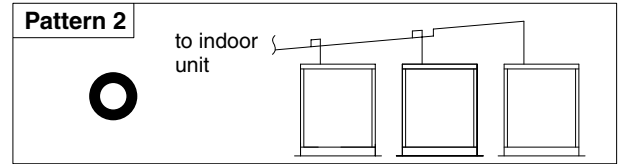
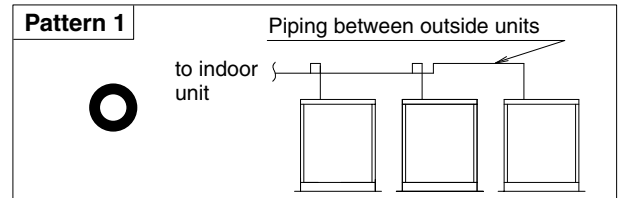

Change to pattern 1 or pattern 2

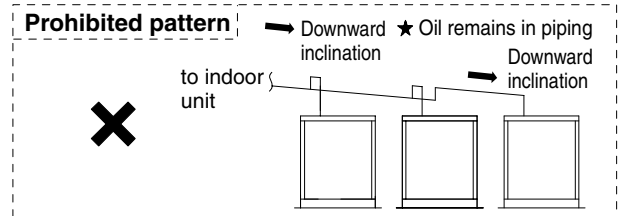

2. The gas piping (both discharge and suction gas pipings in case of the heat recovery system) after branched, install without fail a trap of 8 in. or more using the piping included in the piping kit for connecting the outside unit. Otherwise, the refrigerant may stay within the piping, causing any damage to the outside unit.

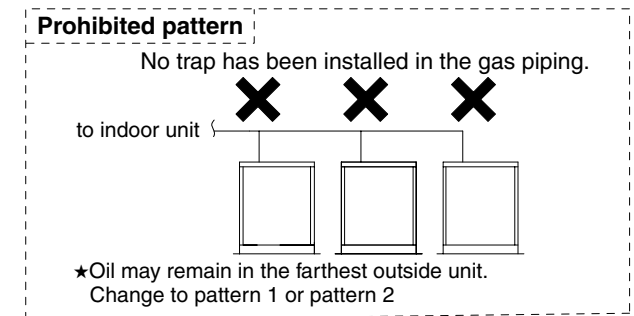
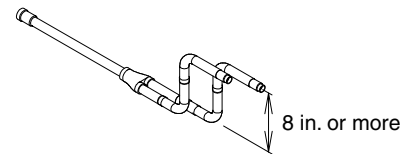

3. If the piping length between the outside unit connecting pipe kit or between the outside units exceeds 80 in., create a rise of 8 in. or more in the gas line within a length of 80 in. from the kit.

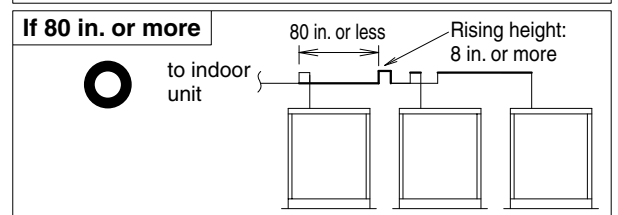
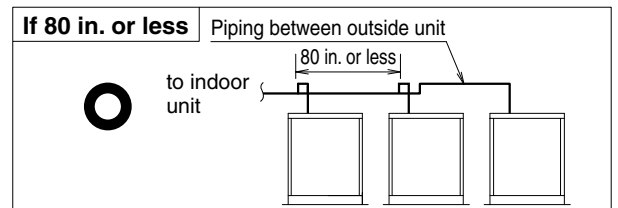

9-5 Example of connection

* In case of a system of switching between cooling and heating, all systems use 2-tube piping (for suction gas piping and liquid piping). No BS unit is required.

Example of connection

(Connection of 6 indoor units Heat pump system) (2-tube piping) Indoor unit side Suction gas piping Liquid piping

• Piping between outside unit and BS unit
 — (Thick line): 3-tube piping (Suction gas piping) (Discharge gas piping) (Liquid piping)
 — (Thin line): 2-tube piping (Liquid piping)

If the system capacity is RWEYQ144 or more, refer to the (outside unit) as the first outside branch seen from the indoor unit side.

Branch with REFNET joint

Example 1: REFNET joint (A-G)

Example 2: REFNET joint (A-B)

Example 3: REFNET header

Example 4: REFNET joint (A-G)

Example 5: REFNET header

Example 6: REFNET header

Refrigerant branch kit selection

Refrigerant branch kits can only be used with R410A.

Indoor capacity unit	Heat recovery system	Refrigerant branch kit name
RWEYQ72, 84	KHRP26M33T	KHRP26M33H
RWEYQ144, 168	KHRP26M72TU	KHRP26M72H
RWEYQ216, 252	KHRP26M73TU	KHRP26M73HU

• For REFNET joints other than the first branch, select the proper branch kit model based on the total capacity index.

Indoor capacity index	In case of 3-tube piping	Heat recovery system
72	KHRP26M22T	KHRP26M22H
725x<111	KHRP26M33T	KHRP26M33H
1115x<246	KHRP26M72TU	KHRP26M72H
2465	KHRP26M73TU	KHRP26M73HU

• Select from the following table in accordance with the capacity of the outside unit. (Example 1, 2, 4, 5: REFNET joint)

Pipe size selection

For an outside unit multi installation (RWEYQ144, 168, 216, 252 type), make the settings in accordance with the following figure.

Piping between outside unit and refrigerant branch kit (part A)

Piping between outside branches (part B)

How to calculate the additional refrigerant to be charged

Additional refrigerant to be charged R (lbs) (R should be rounded off in units of 0.1 lbs.)

NOTE: If a negative result is gotten for R from the formula at right, no refrigerant needs to be added.

Branch with REFNET joint and REFNET header

Example 2: REFNET joint (A-B)

Example 5: REFNET header

Branch with REFNET header

Example 3: REFNET header

Example 6: REFNET header

Refrigerant branch kit selection

How to select REFNET joints:

- Choose from the following table in accordance with the capacity of the outside unit. (Example 1, 2, 4, 5: REFNET joint)

Indoor capacity index	Refrigerant branch kit name	In case of 2-tube piping
72	KHRP26M33H	KHRP26M33H
725x<111	KHRP26M72H	KHRP26M72H
1115x<246	KHRP26M73HU	KHRP26M73HU
2465	KHRP26M73HU	KHRP26M73HU

How to select REFNET header:

- Select from the table below according to the total capacity index. (Example 3, 6: unit) (a: o ≤ 390 ft)

Indoor capacity index	Heat recovery system	Heat pump system
2 unit	BHFP26MA56U	BHFP26MA56U
3 unit	BHFP26MA84U	BHFP26MA84U

How to select REFNET header:

- Choose from the table below according to the total capacity of indoor units to be connected to the downstream of REFNET header. (Example 3, 6: unit) (a: o ≤ 390 ft)

Indoor capacity index	Refrigerant branch kit name	In case of 2-tube piping
72	KHRP26M33H	KHRP26M33H
725x<111	KHRP26M72H	KHRP26M72H
1115x<246	KHRP26M73HU	KHRP26M73HU
2465	KHRP26M73HU	KHRP26M73HU

How to select outside branch kit (Needed when the outside unit type is RWEYQ144 or more.)

Number of units of outside unit	Heat recovery system	Heat pump system
2 unit	BHFP26MA56U	BHFP26MA56U
3 unit	BHFP26MA84U	BHFP26MA84U

How to select REFNET header:

- Select from the table below according to the total capacity index. (Example 3, 6: unit) (a: o ≤ 390 ft)

Indoor capacity index	Refrigerant branch kit name	In case of 2-tube piping
72	KHRP26M33H	KHRP26M33H
725x<111	KHRP26M72H	KHRP26M72H
1115x<246	KHRP26M73HU	KHRP26M73HU
2465	KHRP26M73HU	KHRP26M73HU

How to calculate the additional refrigerant to be charged

Additional refrigerant to be charged R (lbs) (R should be rounded off in units of 0.1 lbs.)

NOTE: If a negative result is gotten for R from the formula at right, no refrigerant needs to be added.

9-6 Air tight test and vacuum drying

The units were checked for leaks by the manufacturer. Confirm that the valves are firmly closed before Air tight test or vacuum drying.

To prevent entry of any impurities and ensure sufficient pressure resistance, always use the special tools dedicated for R410A.

- **Air tight test:** Make sure to use nitrogen gas.

(For the service port location, refer to the "Caution" label attached on the front panel [right] of the outside unit.)

(Refer to figure)

1. [Service precautions] Label
2. Electrical components box lid
3. [Caution] Label

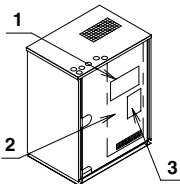

Pressurize the liquid and gas pipes to 450 psi (do not pressurize more than 450 psi). If the pressure does not drop within 24 hours, the system passes the test. If the pressure drops, check where the nitrogen leaks from.

- **Vacuum drying:** Use a vacuum pump which can evacuate to -14.6 psi.
 1. Evacuate the system from the liquid and gas pipes by using a vacuum pump for more than 2 hours and bring the system to -14.6 psi or less. After keeping the system under that condition for more than 1 hour, check if the vacuum gauge rises or not. If it rises, the system may either contain moisture inside or have leaks.
 2. Following should be executed if there is a possibility of moisture remaining inside the pipe (if piping work is carried out during the raining season or over a long period of time rainwater may enter the pipe during work).
After evacuating the system for 2 hours, pressurize the system to 7.25 psi (vacuum break) with nitrogen gas and evacuate the system again using the vacuum pump for 1 hour to -14.6 psi or less (vacuum drying). If the system cannot be evacuated to -14.6 psi within 2 hours, repeat the operation of vacuum break and vacuum drying.
Then, after leaving the system in vacuum for 1 hour, confirm that the vacuum gauge does not rise.

NOTE

Make sure to perform air tight test and vacuum drying using the service ports of the stop valve shown in the table below.

One outside unit installed	Liquid line stop valve Discharge gas line stop valve Suction gas line stop valve
Multiple outside units installed	Liquid line stop valve Discharge gas line stop valve Suction gas line stop valve Oil-equalizing line stop valve

9-7 Pipe insulation

After finishing the leak test and vacuum drying, the piping must be insulated. Take into account the following points:

- Make sure to insulate the connection piping and refrigerant branch kits entirely.
- Be sure to insulate the liquid-side, suction gas-side and discharge gas-side piping for the inter-unit piping and the refrigerant branch kits. Not insulating them may cause leaking. (The gas piping can reach temperatures of 250 °F. Be sure the insulation used can withstand such temperatures.)
- If you think the humidity around the cooling piping might exceed 86 °F and RH80%, reinforce the insulation on the cooling piping (at least 13/16" thick). Condensation might form on the surface of the insulation.
- If there is a possibility that condensation on the stop valve might drip down into the indoor unit through gaps in the insulation and piping because the outside unit is located higher than the indoor unit, etc., this must be prevented by caulking the connections, etc.

WARNING

- Be sure to insulate connection piping, as touching them can cause burns.

9-8 Checking of device and installation conditions

Be sure to check the followings.

1. Make sure there is no faulty power wiring or loosening of a nut. See "8. FIELD WIRING".
2. Make sure there is no faulty transmission wiring or loosening of a nut. See "8. FIELD WIRING".
3. Make sure there is no faulty refrigerant piping. See "9. REFRIGERANT PIPING".
4. Make sure piping size is correct. See "9-1 Selection of piping material".
5. Make sure insulation work is done. See "9-7 Pipe insulation".
6. Make sure insulation resistance of main power circuit is not deteriorated.
Using a megatester for 500V, check that the insulation resistance of 2MΩ or more is attained by applying a voltage of 500V DC between power terminals and earth. Never use the megatester for the transmission wiring (between outside and indoor unit, outside and COOL/HEAT selector and etc.).

9-9 Additional refrigerant charge

WARNING

- To avoid injury always use protective gloves and eye protection when charging refrigerant.
- To avoid injury do not charge with unsuitable substances. Use only the appropriate refrigerant.

NOTE

- Refrigerant cannot be charged until field wiring has been completed.
Refrigerant may only be charged after performing the leak test and the vacuum drying (see above).
When charging a system, care shall be taken that its maximum permissible charge is never exceeded, in view of the danger of liquid hammer.
Refrigerant containers shall be opened slowly.

TO AVOID COMPRESSOR BREAKDOWN. DO NOT CHARGE THE REFRIGERANT MORE THAN THE SPECIFIED AMOUNT TO RAISE THE CONDENSING PRESSURE.

- This outside unit is factory charged with refrigerant and depending on pipe sizes and pipe lengths some systems require additional charging of refrigerant.
- Determine the amount of refrigerant to be added by referring to the table, write it down on the included "Added Refrigerant" plate and attach it to the rear side of the front cover.
Note: refer to the example of connection for the amount to be added.

Additional refrigerant charge procedure (1)-normally

- Charge the refrigerant to the liquid pipe in its liquid state. Since R410A is a mixed refrigerant, its composition changes if charged in a state of gas and normal system operation would no longer be assured.
 - Make sure to use installation tools you exclusively use on R410A installations to withstand the pressure and to prevent foreign materials from mixing into the system.
1. Before charging, check whether the tank has a siphon attached or not.

How to charge with the siphon tank.

Charge with the tank upright.

(There is a siphon tube inside, so there is no need to turn the tank upside-down.)



Other ways of charging with the tank.

Charge with the tank upside-down.



2. After the vacuum drying is finished, charge the additional refrigerant in its liquid state through the liquid stop valve service port. Taking into account following instructions:

- Check that gas and liquid stop valves are closed.
- Stop the compressor and charge the specified weight of refrigerant.

(If the outside unit is not in operation and the total amount cannot be charged, follow the Additional refrigerant charge procedure (2) shown below.)

NOTE

- Procedures for charging additional refrigerant. (Refer to figure 24)

1. Pressure reducing valve
2. Nitrogen
3. Refrigerant tank
4. With a siphon
5. Measuring instrument
6. Vacuum pump
7. Valve A
8. Valve B
9. Charge hose
10. Outside unit
11. Gas side
12. Liquid side
13. Discharge gas side
14. Suction gas side
15. Stop valve service port
16. To indoor unit
17. To indoor units / BS units
18. Dotted lines represent onsite piping

Additional refrigerant charge procedure (2)-by Additional refrigerant charge operation

To learn the system settings for additional refrigerant charging, refer to the [Service Precaution] label attached on the back of the electric box lid in the outside unit.

1. Fully open all stop valves (valve A and valve B must be left fully closed).
2. After ten minutes, fully close liquid line stop valve and then, open the valve by turning 180°. Start the additional refrigerant charge operation. See [Service precautions] Label for detail. If it is difficult to charge the refrigerant additionally, decrease the water temperature or warm the refrigerant tank. (Warm the refrigerant tank with a stupe or a warm hot water of 104 °F or less.)
3. After the system is charged with a specified amount of refrigerant, press the RETURN button (BS3) on the PC board (A1P) in the outside unit to stop the additional refrigerant charge operation.
4. Immediately open both liquid-side and gas-side stop valve. (If do not open the stop valve immediately, liquid seal may cause the pipe to burst.)



NOTE

- If the refrigerant cylinder is siphonal, set it upright while charging additional refrigerant.

9-10 Stop valve operation procedure



CAUTION

Do not open the stop valve until 1-6 of "9-8 Checking of device and installation conditions" are completed. If the stop valve is left open without turning on power, it may cause refrigerant to buildup in the compressor, leading to insulation degradation.

Opening stop valve

1. Remove the cap and turn the valve counterclockwise with the hexagon wrench.
2. Turn it until the shaft stops.
Do not apply excessive force to the stop valve. Doing so may break the valve body, as the valve is not a backseat type. Always use the special tool.
3. Make sure to tighten the cap securely.

Closing stop valve

1. Remove the cap and turn the valve clockwise with the hexagon wrench.
2. Securely tighten the valve until the shaft contacts the main body seal.
3. Make sure to tighten the cap securely.
* For the tightening torque, refer to the table on the below.

Tightening torque

Stop valve size	Tightening torque ft.-lbf. (Turn clockwise to close)					
	Shaft (valve body)	Cap (valve lid)	Service port	Flare nut	Gas side accessory pipe (1)	
Liquid side	3.98-4.87	Hexagonal wrench 1/8 in.	9.95-12.17	8.48-10.25	24.1-29.4	—
Gas side	19.91-24.33	Hexagonal wrench 3/8 in.	26.54-32.44	8.48-10.25	—	16.22-20.65

(Refer to figure 25)

1. Service port
2. Cap
3. Hexagon hole
4. Shaft
5. The main body seal

(Caution)

- Do not damage the cap sealing.
- Always use a charge hose for service port connection.
- After tightening the cap, check that no refrigerant leaks are present.
- After working, securely tighten the cover of service port without fail by specified torque.
- When loosening a flare nut, always use two wrenches in combination. When connecting the piping, always use a spanner and torque wrench in combination to tighten the flare nut.
- When connecting a flare nut, coat the flare (inner and outer faces) with ether oil or ester oil and hand-tighten the nut 3 to 4 turns as the initial tightening.
- Do not forget to open the stop valve before starting operation.

(Refer to figure 26)

1. Remove the cap and turn the valve counterclockwise with the hexagon wrenches until it stops.
2. Discharge gas side
3. Liquid side
4. Suction gas side
5. Never remove the partition flange for any reason.
6. Full close on the suction gas side

10. CHECKS AFTER INSTALLATION

WARNING

- Never connect power supply wiring to the terminal block for remote controller wiring as this could damage the entire system.
- Attach the power wire securely.
- To avoid injury, always make sure that the circuit breaker on the power supply panel of the installation is switched off before doing any work.

After the installation, check the following before switching on the circuit breaker:

1. The position of the switches that requires an initial setting
Make sure that switches are set according to your application needs before turning the power supply on.
2. Power supply wiring and transmission wiring
Use a designated power supply and transmission wiring and make sure that it has been carried out according to the instructions described in this manual, the wiring diagrams and local and national regulations.
3. Pipe sizes and pipe insulation
Make sure that correct pipe sizes are installed and that the insulation work is properly executed.
4. Additional refrigerant charge
The amount of refrigerant to be added to the unit should be written on the included "Additional Refrigerant" label, and attach it to the rear side of the front cover.
5. Measurement of insulation in main power circuit
Using a megatester for 500V, check that the insulation resistance of 2MΩ or more is attained by applying a voltage of 500V DC between power terminals and earth. Never use the megatester for the transmission wiring.
6. Installation date
Be sure to keep record of the installation date on the "Additional Refrigerant" label.

11. TEST RUN

CAUTION

After completing installation, be sure to open the valves.
(Operating the unit with the valves shut will break the compressor.)

11-1 Air discharge

- Running the heat source water pump, carry out air discharge process until the water comes out from the air discharge hole of local piping.
(For the operation to be done for the first time after installation, you need to perform a checking operation.)

11-2 Before turn on the power supply

- Close the electrical components lid securely before turning on power.
- Make settings for outside unit PC board (A1P) after power-on and check the LED display from inspection door that is on the electrical components box lid.

11-3 Check operation

When running the unit for the first time after installation, be sure to perform a test operation following these steps. (Not performing a test operation when the unit is first installed may prevent the unit from operating properly.)

- During the operation, monitor the outdoor unit operation status and check for any incorrect wiring.

(1) Check the connection of interlock circuit	The outside unit cannot be operated if the interlock circuit has not been connected.																																																																																										
(2)• As necessary, configure the system settings onsite by using the dipswitch (DS1) on the outside unit PC-Board (A1P) and push button switches (BS1 to 5). • When the system is in the multiple-outside unit configuration (Out Multi), perform the configuration on the main unit. (Any settings made on a sub unit will be ignored.) After this, close the electrical components box lid.	Always perform configuration after turning ON the power. To learn the setting method, refer to the [Service Precautions] label attached at the position shown in the figure on the right (Electric box lid in outside unit). (Remember, the actual settings you have made must be recorded on the [Service Precautions] label.)																																																																																										
(3) Turn ON the power to the outside units and indoor units.	Make sure to turn ON the power 6 hours before starting the operation. This is necessary to warm the crankcase preliminarily by the electric heater.																																																																																										
(4) Start the heat source water pump and fill the heat source water in the outside unit.	The outside unit cannot be operated if the heat source water pump is not running.																																																																																										
(5) Make sure that the temperature of heat source water is kept within the operation range (60 - 100 °F).	The outside unit cannot be operated at a temperature outside the operation range.																																																																																										
(6) Check the LED on the PC board (A1P) in the outside unit to see if the data transmission is performed normally.	<table border="1"> <thead> <tr> <th rowspan="2">LED display (Default status before delivery)</th> <th colspan="3">Microcomputer operation monitor</th> <th colspan="3">Page</th> <th colspan="3">Ready/Error</th> <th colspan="3">Cooler/heater changeover</th> <th rowspan="2">Low noise</th> <th rowspan="2">Demand</th> <th rowspan="2">Multi</th> </tr> <tr> <th>HAP</th> <th>H1P</th> <th>H2P</th> <th>H3P</th> <th>H4P</th> <th>H5P</th> <th>H6P</th> <th>H7P</th> <th>H8P</th> <th>Individual</th> <th>Bulk (main)</th> <th>Bulk (sub)</th> </tr> </thead> <tbody> <tr> <td>One outside unit installed</td> <td>●</td> <td>●</td> <td>●</td> <td>○</td> <td>●</td> <td>●</td> <td>●</td> <td>●</td> <td>●</td> <td>●</td> <td>●</td> <td>●</td> <td>●</td> <td>●</td> <td>●</td> </tr> <tr> <td rowspan="3">When multiple outside unit installed (※)</td> <td>Master station</td> <td>●</td> <td>●</td> <td>●</td> <td>○</td> <td>●</td> <td>●</td> <td>●</td> <td>●</td> <td>●</td> <td>●</td> <td>●</td> <td>●</td> <td>●</td> <td>○</td> </tr> <tr> <td>Sub station 1</td> <td>○</td> <td>●</td> <td>●</td> <td>●</td> <td>●</td> <td>●</td> <td>●</td> <td>●</td> <td>●</td> <td>●</td> <td>●</td> <td>●</td> <td>●</td> <td>●</td> </tr> <tr> <td>Sub station 2</td> <td>○</td> <td>●</td> <td>●</td> <td>●</td> <td>●</td> <td>●</td> <td>●</td> <td>●</td> <td>●</td> <td>●</td> <td>●</td> <td>●</td> <td>●</td> <td>●</td> </tr> </tbody> </table> <p>LED display: ● OFF ○ ON ● Blinking</p> <p>(※) The base (main) unit is the outside unit to which the interconnecting wiring for the indoor units is connected. The other outside units are sub units.</p>	LED display (Default status before delivery)	Microcomputer operation monitor			Page			Ready/Error			Cooler/heater changeover			Low noise	Demand	Multi	HAP	H1P	H2P	H3P	H4P	H5P	H6P	H7P	H8P	Individual	Bulk (main)	Bulk (sub)	One outside unit installed	●	●	●	○	●	●	●	●	●	●	●	●	●	●	●	When multiple outside unit installed (※)	Master station	●	●	●	○	●	●	●	●	●	●	●	●	●	○	Sub station 1	○	●	●	●	●	●	●	●	●	●	●	●	●	●	Sub station 2	○	●	●	●	●	●	●	●	●	●	●	●	●	●
LED display (Default status before delivery)	Microcomputer operation monitor			Page			Ready/Error			Cooler/heater changeover			Low noise	Demand				Multi																																																																									
	HAP	H1P	H2P	H3P	H4P	H5P	H6P	H7P	H8P	Individual	Bulk (main)	Bulk (sub)																																																																															
One outside unit installed	●	●	●	○	●	●	●	●	●	●	●	●	●	●	●																																																																												
When multiple outside unit installed (※)	Master station	●	●	●	○	●	●	●	●	●	●	●	●	●	○																																																																												
	Sub station 1	○	●	●	●	●	●	●	●	●	●	●	●	●	●																																																																												
	Sub station 2	○	●	●	●	●	●	●	●	●	●	●	●	●	●																																																																												
(7)• Using the push button switches (BS1 - 5) on the PC board (A1P) of outside unit, carry out a local setting, if necessary. • When the system is in the multiple-outside unit configuration (Out Multi), perform the configuration on the main unit. (Any settings made on a sub unit will be ignored.)	Always perform configuration after turning ON the power. To learn the setting method, refer to the [Service Precautions] label attached at the position shown in the figure on the right (Electric box lid in outside unit). (Remember, the actual settings you have made must be recorded on the [Service Precautions] label.)																																																																																										
(8) Check all stop valves are opened. If some stop valve is closed, open them. (Refer to "9-10 Stop valve operation procedure".)	[CAUTION] Do not leave any stop valve closed. Otherwise the compressor will fail. For Heat recovery system of cooling and heating: Open all stop valves on the suction side, discharge gas side and liquid side. For cooling and heating switching operation system: Open the stop valves on discharge gas side and liquid side. (Keep the stop valve on suction side fully closed.)																																																																																										
(9) Perform the check operation following the instructions printed on the [Service Precautions] label.	If you push the test run button (BS4) on the PC board (A1P) of the outside unit for 5 seconds, the test run starts. If you want to interrupt the test run, push the RETURN button (BS3) on PC board (A1P) of the outside unit. The system continues residual operation for about 1 minute (maximum 10 minutes) and then stops. (During test run, you cannot stop it by a command from a remote controller.) You need to perform the above settings on the PCB by accessing the PCB through the inspection cover on the switch box cover.																																																																																										

(Refer to figure 27)

1. Electrical components box
2. Electrical components box lid
3. Service lid
4. Inspection cover
5. [Service precaution] Label

(Cautions for check operation)

- If the system is started within about 12 minutes after the outdoor/indoor units are turned ON, the compressor will not run and H2P lights up. Before starting an operation, always verify that the LED display shows the contents of the table in “11-3 Check operation (6)”.
- The system may require up to 10 minutes until it can start the compressor after an operation start. This is a normal operation to equalize the refrigerant distribution.
- The check operation does not provide any means of checking the indoor units individually. For that purpose, perform normal operation using the remote controller after the check operation.
- Check operation is not possible in other modes such as collection mode.
- If the setting of indoor remote controller is changed before the check operation, it may not be performed correctly and malfunction code “UF” may be displayed.

Remote controller displays malfunction code

Malfunction code	Installation error	Remedial action
E3 E4 F3 F6 UF U2	The stop valve of an outside unit is left closed.	Open the stop valve. Check referring to the table in “9-9 Additional refrigerant charge”.
U1	The phases of the power to the outside units are reversed.	Exchange two of the three phases (L1, L2, L3) to make a positive phase connection.
U1 U2 U4	No power is supplied to an outside or indoor unit (including phase interruption).	Check if the power wiring for the outside units are connected correctly. (If the power wire is not connected to L2 phase, no malfunction display will appear and the compressor will not work.) Check if the ground fault circuit interrupter in the outside unit is ON.
UF	Incorrect transmission between units	Check if the refrigerant piping line and the unit transmission wiring are consistent with each other.
E3 F6 UF U2	Refrigerant overcharge	Recalculate the required amount of refrigerant from the piping length and correct the refrigerant charge level by recovering any excessive refrigerant with a refrigerant recovery machine.
E4 F3	Insufficient refrigerant	<ul style="list-style-type: none"> • Check if the additional refrigerant charge has been finished correctly. • Recalculate the required amount of refrigerant from the piping length and add an adequate amount of refrigerant.
U7 UF	If an outside multi terminal is connected when there is one outside unit installed	Remove the line from the outside multi terminals (Q1 and Q2).
UF E4	The operation mode on the remote controller was changed before the check operation.	Set the operation mode on all indoor unit remote controllers to “cooling.”
HJ	The heat source water is not circulating.	Make sure that the water pump is running.
U3	The check operation has not been performed.	Perform the check operation.

11-4 Check of normal operation

After the check operation is completed, operate the unit normally. (Heating is not possible if the outdoor temperature is 75 °F or higher. Refer to the Operation manual.)

Check the below items.

- Make sure the indoor and outside units are operating normally (If a knocking sound can be heard in the liquid compression of the compressor, stop the unit immediately and then energize the heater for a sufficient length of time before restarting the operation.)
- Run each indoor unit one at a time and make sure the corresponding outside unit is also running.
- Check to see if cold (or hot) air is coming out of the indoor unit.
- Press the fan direction and fan strength buttons on the indoor unit to check if they operate properly.

NOTE

(Cautions for normal operation check)

- Once stopped, the compressor will not restart in about 5 minutes even if the Run/Stop button of an indoor unit in the same system is pressed.
- When the system operation is stopped by the remote controller, the outside units may continue operating for further 5 minutes at maximum.
- If the system has not undergone any check operation by the test operation button since it was first installed, a malfunction code “U3” is displayed. In this case, perform check operation referring to “11-3 Check operation”.
- After the test operation, when handing the unit over to the customer, make sure the electric box lid, the service lid, and the unit casing are all attached.

12. CAUTION FOR REFRIGERANT LEAKS

DANGER

- Refrigerant gas is heavier than air and replaces oxygen. A massive leak could lead to oxygen depletion, especially in basements, and an asphyxiation hazard could occur leading to serious injury or death.

(Points to note in connection with refrigerant leaks)

Introduction

The installer and system specialist shall secure safety against leakage according to local regulations or standards. The following standards may be applicable if local regulations are not available.

The VRV System, like other air conditioning systems, uses R410A as refrigerant. R410A itself is an entirely safe non-toxic, non-combustible refrigerant. Nevertheless care must be taken to ensure that air conditioning facilities are installed in a room which is sufficiently large. This assures that the maximum concentration level of refrigerant gas is not exceeded, in the unlikely event of major leak in the system and this in accordance to the local applicable regulations and standards.

Maximum concentration level

The maximum charge of refrigerant and the calculation of the maximum concentration of refrigerant is directly related to the humanly occupied space in to which it could leak.

The unit of measurement of the concentration is lb./ft³ (the weight in lb. of the refrigerant gas in 1ft³ volume of the occupied space).

Compliance to the local applicable regulations and standards for the maximum allowable concentration level is required.

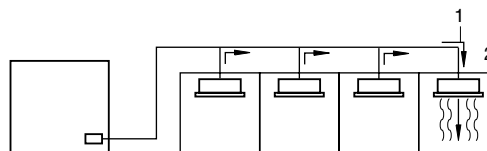

1. direction of the refrigerant flow
2. room where refrigerant leak has occurred (outflow of all the refrigerant from the system)

Pay a special attention to the place, such as a basement, etc. where refrigerant can stay, since refrigerant is heavier than air.

Procedure for checking maximum concentration

Check the maximum concentration level in accordance with steps 1 to 4 below and take whatever action is necessary to comply.

1. Calculate the amount of refrigerant (lb.) charged to each system separately.

amount of refrigerant in a single unit system (amount of refrigerant with which the system is charged before leaving the factory)	+	additional charging amount (amount of refrigerant added locally in accordance with the length or diameter of the refrigerant piping)	=	total amount of refrigerant (lb.) in the system
---	---	--	---	---

NOTE

- Where a single refrigerant facility is divided into 2 entirely independent refrigerant systems then use the amount of refrigerant with which each separate system is charged.

2. Calculate the smallest room volume (ft³)
In case like the following, calculate the volume of (A), (B) as a single room or as the smallest room.

- A. Where there are no smaller room divisions

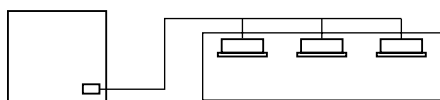

- B. Where there is a room division but there is an opening between the rooms sufficiently large to permit a free flow of air back and forth.

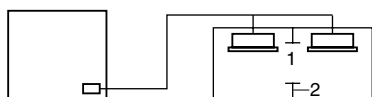

1. opening between rooms
2. partition

(Where there is an opening without a door or where there are openings above and below the door which are each equivalent in size to 0.15% or more of the floor area.)

3. Calculating the refrigerant density using the results of the calculations in steps 1 and 2 above.

$$\frac{\text{total volume of refrigerant in the refrigerant system}}{\text{size (ft}^3\text{) of smallest room in which there is an indoor unit installed}} \leq \text{maximum concentration level (lb./ft}^3\text{)}$$

If the result of the above calculation exceeds the maximum concentration level then make similar calculations for the second then third smallest room and so until the result falls short of the maximum concentration.

4. Dealing with the situations where the result exceeds the maximum concentration level.

Where the installation of a facility results in a concentration in excess of the maximum concentration level then it will be necessary to revise the system. Please consult your Daikin supplier.

DAIKIN AC (AMERICAS), INC.

1645 Wallace Drive, Suite 110
Carrollton, TX 75006

info@daikinac.com
www.daikinac.com

DAIKIN INDUSTRIES, LTD.

Head office:
Umeda Center Bldg., 2-4-12, Nakazaki-Nishi,
Kita-ku, Osaka, 530-8323 Japan

Tokyo office:
JR Shinagawa East Bldg., 2-18-1, Konan,
Minato-ku, Tokyo, 108-0075 Japan

